

virtuafit

Elite FDR 2.4i Crosstrainer

User manual

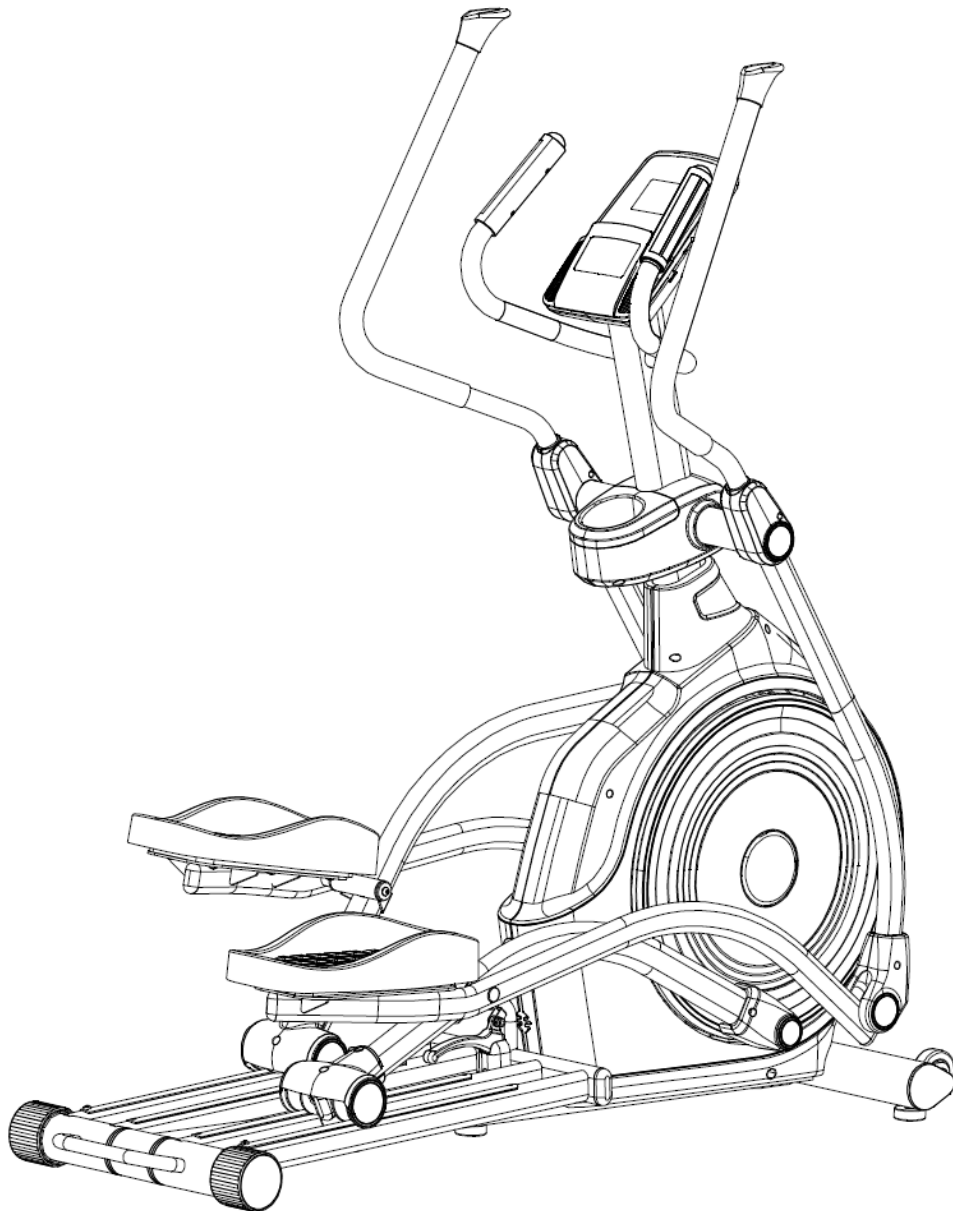

SAFETY INSTRUCTIONS	3 - 4
ASSEMBLY INSTRUCTIONS	5 - 8
MAINTENANCE	9
TROUBLE SHOOTING	10
CONTROL PANEL	11 - 17
APP INSTRUCTIONS	18
EXPLODED DRAWING	19
PARTS LIST	20 - 21
TRAINING INSTRUCTIONS	22

WARNING:

Before beginning any exercise program consult your physician. This is especially important for people who are over 35 years old or who have pre-existing health problems. Read all instructions before using any fitness equipment. Do not operate this device without properly fitted guards, as the moving parts can present a risk of serious injury if exposed.

ATTENTION

- It is important to read this entire manual before assembling and using the device. Safe and effective use can only be achieved if the device is assembled, maintained and used properly. It is your responsibility to ensure that all users of the device are informed of all warnings and precautions.
- Before starting any exercise program, you should consult your doctor to determine if you have any medical or physical conditions that could put your health and safety at risk, or prevent you from using the device properly. Your doctor's advice is essential if you are taking medication that affects your heart rate, blood pressure or cholesterol level.
- Be aware of your body's signals. Incorrect or excessive exercise can damage your health. Stop exercising if you experience any of the following symptoms: pain, tightness in your chest, irregular heartbeat, extreme shortness of breath, lightheadedness, dizziness or feelings of nausea. If you do experience any of these conditions you should consult your doctor before continuing with your exercise program.
- Keep children and pets away from the device. The device is designed for adult use only.
- Use the device on a solid, flat level surface with a protective cover for your floor or carpet. To ensure safety, the device should have at least 0.5 metres of free space all around it.
- Before using the device, check that the nuts and bolts are securely tightened.
- The safety of the device can only be maintained if it is regularly examined for damage and/or wear and tear.

- Always use the device as indicated. If you find any defective components while assembling or checking the device, or if you hear any unusual noises coming from the device during use, stop immediately. Do not use the device until the problem has been rectified.
- Wear suitable clothing while using the device. Avoid wearing loose clothing that may get caught in the device or that may restrict or prevent movement.
- The max user weight is 150 KGS. Braking ability is independent of speed.
- The device is not suitable for therapeutic use.
- Care must be taken when lifting or moving the device so as not to injure your back. Always use proper lifting techniques and/or seek assistance if necessary.
- Please keep the space at least 1 to 2 meter at the end of base frame to escape any accidents!
- Place the device on a clean and flat surface. Do not place the device on a thick carpet.
- The device is for indoor use and not for outdoor use to prevent damage. Keep the storage location dry, clean and flat. It is forbidden to use the device for purposes other than training.
- Only use the machine in an environment with an ambient temperature between 10 °C and 35 °C. Only store the device at an ambient temperature between 5 °C and 45 °C.

Warranty claim is excluded if the cause of the defect is the result of:

- Maintenance assembly and repair work not carried out by an official dealer.
- In the event of improper use, neglect and / or poor maintenance.
- Failure to maintain the device in accordance with the manufacturer's instructions (see the enclosed manual).

Missing parts: If you think you are missing certain parts in your package, carefully check the styrofoam and the device. Some parts (bolts, screws, etc.) are already attached to/in the device.

Error message: Ensure that all cables are carefully attached. The aluminum legs are very sensitive and must remain straight. Do you receive an error message after mounting your device? Then you have to straighten these aluminum legs again, this may cause the error message to disappear.

Socket screws: The device contains socket screws, make sure that the allen key is firmly in the bolt before you apply force to the key. In this way you prevent the head of the socket head screw from being rotated.

NOTE! *The transport wheels must be mounted on the front of the appliance.*

STEP 1

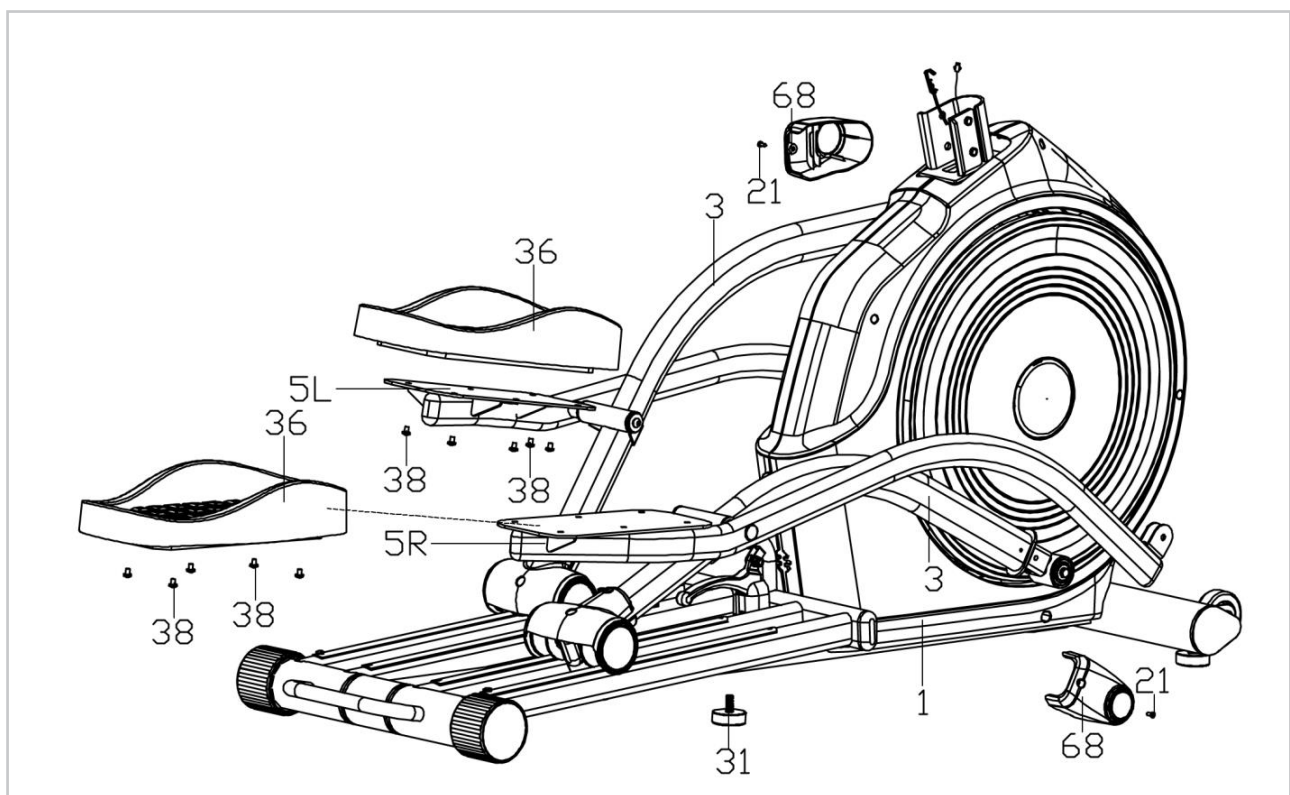

- Lock the adjustable foot pad (31) into the main frame (1) then lock the connecting tube cover (68) on the Roller bracket (3).
- Fix the pedal (36) onto pedal bar (5L/R) by Cross screw (38).

STEP 2

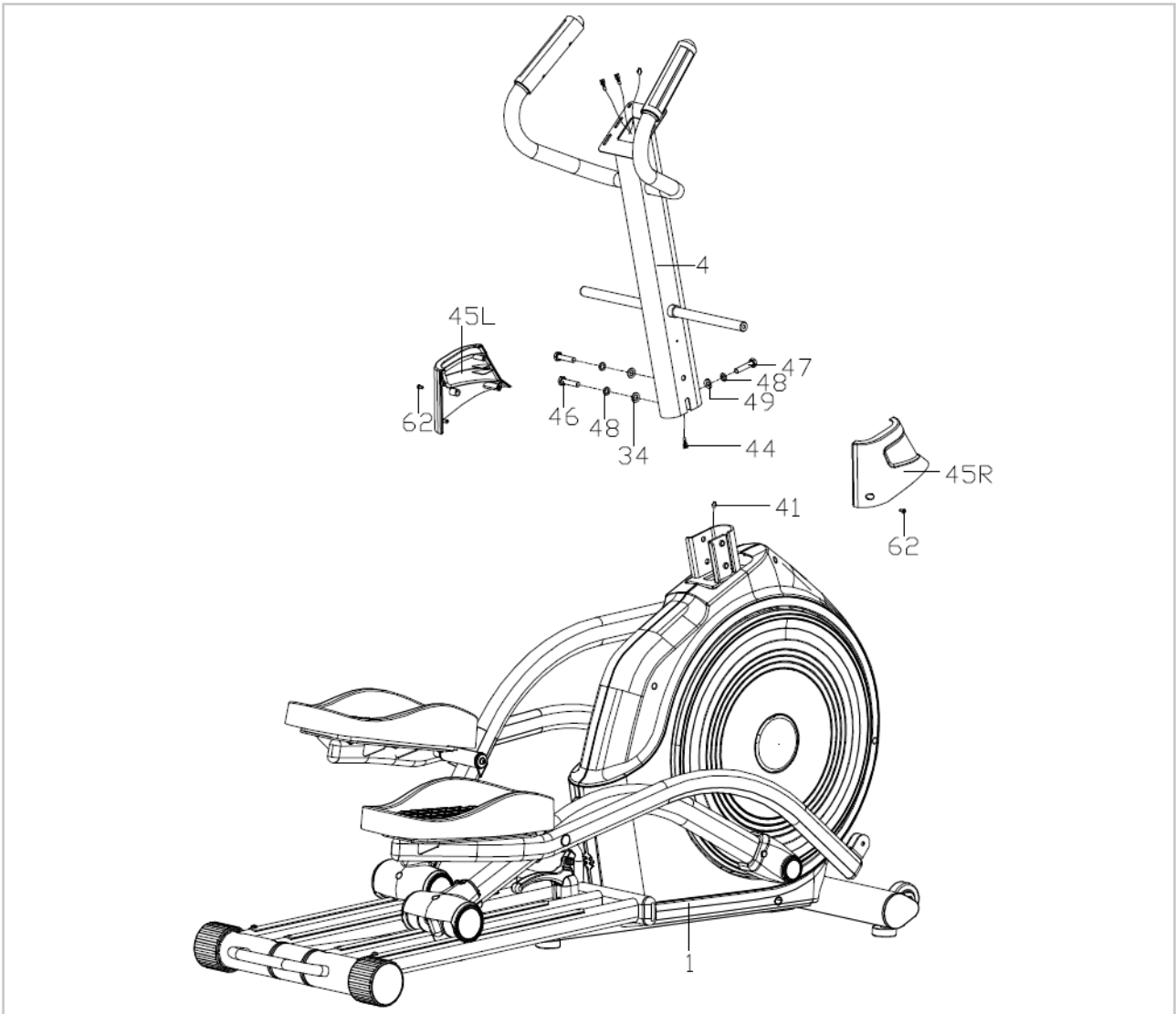

- Connect the sensor wire (41) and extension wire (44) firstly.
- Attach the Handlebar post (4) onto the main frame (1) with Hexagon bolt (46), (47), spring washer (48), flat washer (34) and arc washer (49), then fix the handlebar cover (45L/R) onto the main frame(1) with Phillips tapping screw (62).

STEP 3

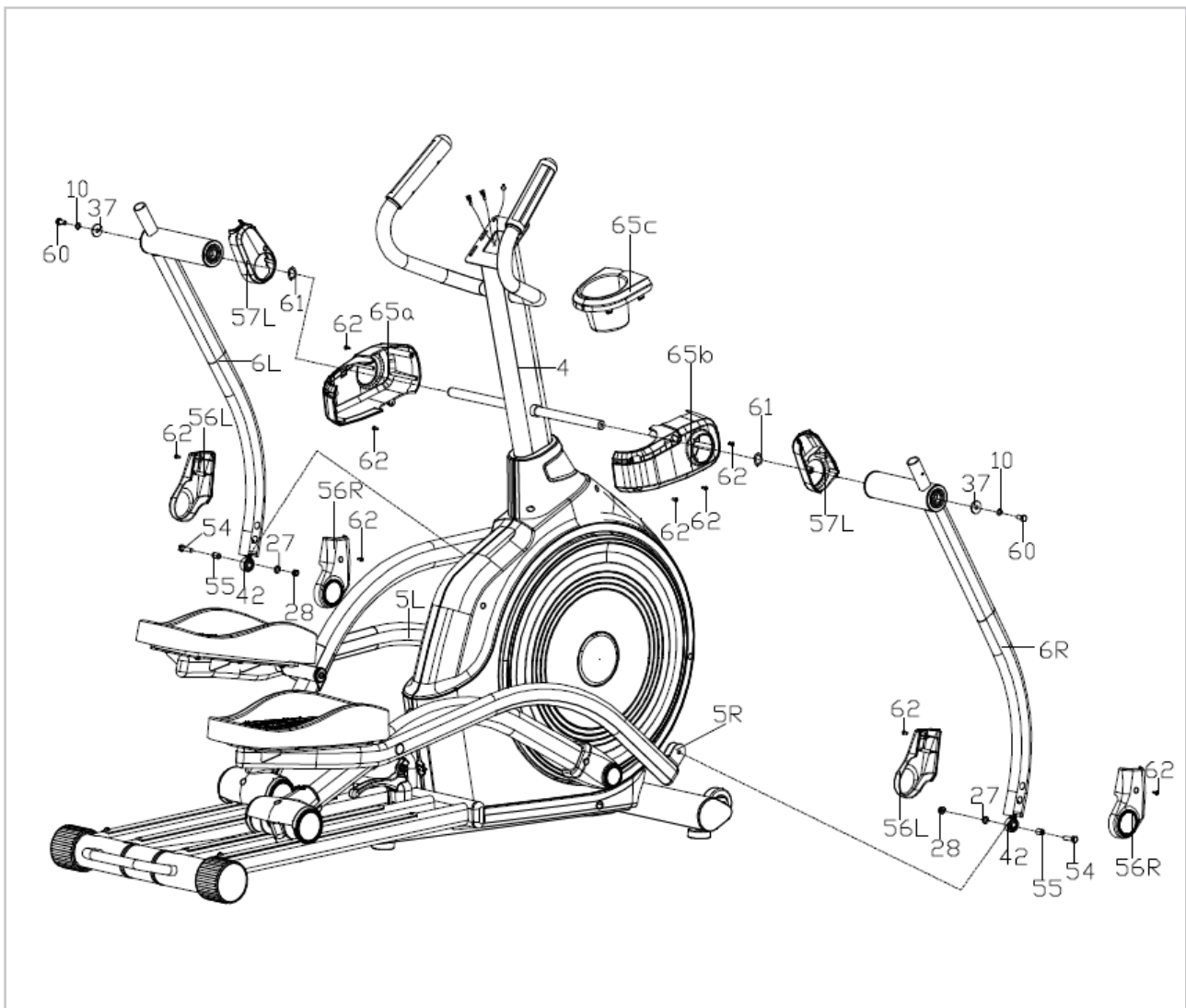

- Attach the swing bar (6L/R), left swing bar cover (57L) and handlebar cover (65 a/b/c) onto handlebar post (4) with hexagon bolt (60), spring washer (10), flat washer (37) and wave washer (61). Please do not tighten them now.
- Lock the swing bar (6L/R) onto the pedal bar (5L/R) by using hexagon bolt (54), bushing (55), universal joint (42), flat washer (27) and nylon nut (28). Then tighten the hexagon bolt (60).
- Fix the pedal bar cover (56L/R) onto the swing bar (6L/R) by Phillips tapping screw (62), then fix the handlebar cover (65 a/b/c) onto the handlebar post (4) with Phillips tapping screw (62).

STEP 4

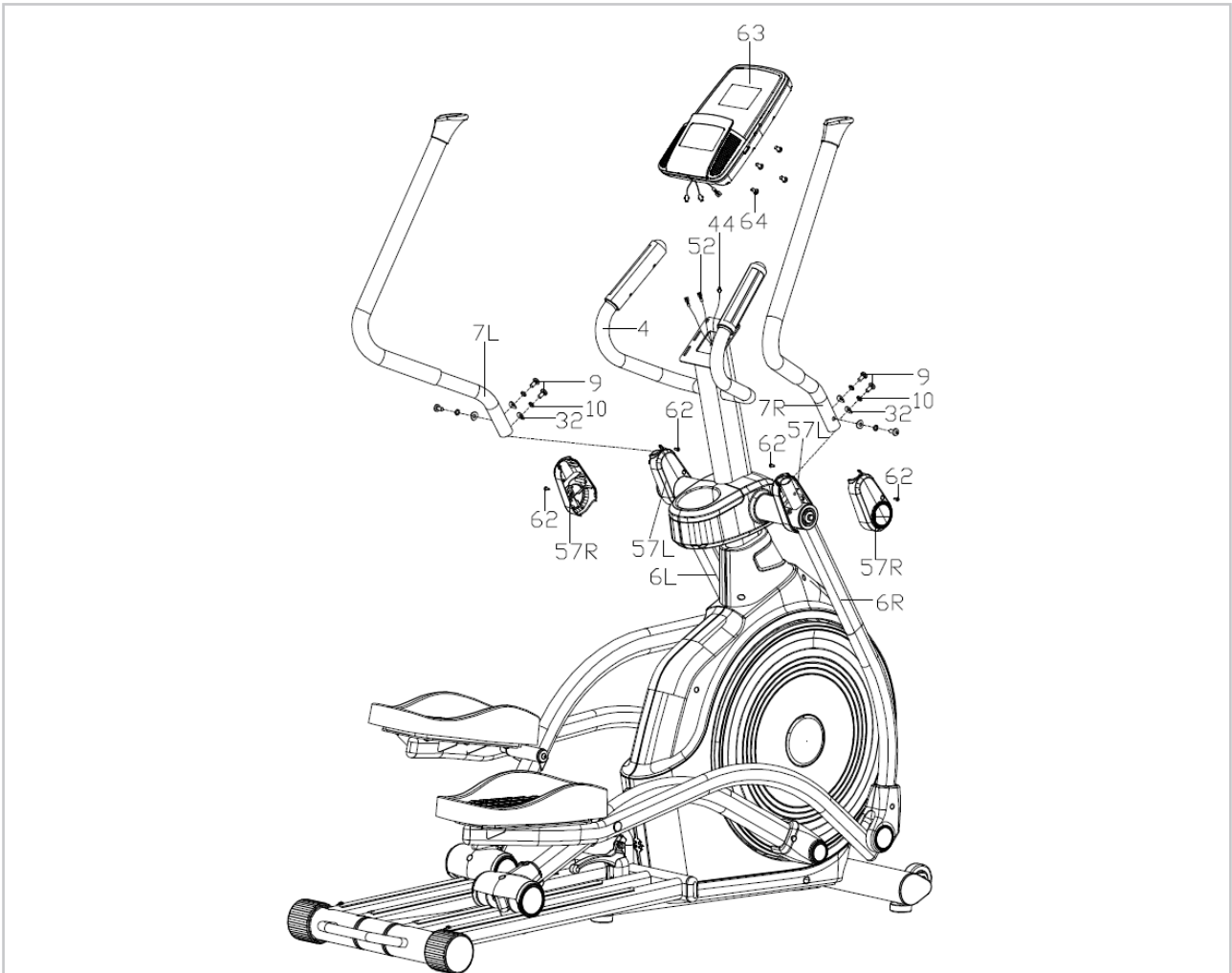

- Lock the handlebar (7L/R) on the swing bar (6L/R) by inner hexagon screw (9), spring washer (10) and arc washer (32), then fix the swing bar cover (57L/R) onto the swing bar (6L/R) with Phillips tapping screw (62).
- Connect the pulse wire (52), extension wire (44) to the console (63), then fix the console (63) on the handlebar post (4) by cross screw (64).

Safe and effective use can only be achieved if the device will be assembled and maintained well. It is your responsibility to ensure that the equipment is regularly maintained. Parts that are already used and / or damaged must be replaced before continuing using. The rower machine may only be used indoors and stored away, prolonged exposure to weathering and changes in temperature / humidity can have a serious impact on the electrical components and moving parts of the device.

DAILY MAINTENANCE

- Clean and remove sweat after each use Do not use aggressive cleaning agents and ensure that the device remains free of moisture.
- Check that the rail and the wheels under the seat are free from dust and dirt.

SEMI-ANNUAL MAINTENANCE

- Inspect all bolts and nuts in connection with moving parts of the device, tighten as required.
- Check the mobility of moving parts and components of the use equipment, silicone spray if necessary.

EXTEND SERVICE LIFE

- The upright is secured with Allen screws, make sure that the bolts are tight at all times. If the bolts are not tight enough anymore, this can cause cracking.
- If the crosstrainer has rails with wheels that roll over it, these rails/wheels every month to be greased with grease. This can be done with vaseline (without acids) or with silicone oil.
- If a main switch is attached to the appliance (on/off), it should always be used after use be turned off.

Display shows no values

If the display does not show any values, you can try to check the sensor cables and the cables in the back of the display. If this still does not work, you can move the sensor slightly.

The device beeps

If necessary, lubricate parts with silicone spray. Check that all nuts and bolts are tightened. It may be that a screw is too loose or too tight, this creates friction and makes the device appear to beep. If this is the case, try to find out exactly where the beep comes from and then tighten or loosen this screw. It must always be possible to loosen the screws with your hands. If this is not possible, the screw is too tight.

No resistance

First check whether you can hear the motor running. You will hear the motor running briefly when you increase or decrease the resistance. If you hear the engine running, all electronics are in order, but the V-belt is probably over. You can then open the housing and put the V-belt back on it. If you do not hear the motor running, it is possible that the motor or the display is defective. First check whether the cable running upwards in the pipe is still properly connected.

Ticking sound

It is possible that the flywheel (in the housing) comes against a cable with each pedaling movement. This may be disturbing but will not permanently damage your crosstrainer. To fix this, open the housing and move the cable or fix it with for example a tie wrap.

Heart rate display is not functioning

There can be various reasons for this:

- The sensor cables that run from the heart rate sensor to the display are not properly installed or have become detached during use.
- The sensors may become damp, dirty or greasy. So you have to clean them regularly.

The console is not working

If there is no signal when pedaling, check if the cable is properly attached.

CONSOLE



BUTTON	FUNCTION
MODE/ENTER	Confirm the setting of a training value.
UP/DOWN	Increase or decrease the resistance level.
RESET	<ul style="list-style-type: none"> Press the button for 2 seconds. The computer will restart at from the setting of the user. Return to the main menu while setting one training value or during stop mode.
START/STOP	Start or stop the workout.
RECOVERY	Test the heart rate recovery status.
BODYFAT	Test body fat in stop mode.

FUNCTIONS

FUNCTION	DESCRIPTION
TIME	<ul style="list-style-type: none"> • Count up - No preset target, Time will count up from 00:00 to maximum 99:59 with each increment is 1 minute. • Count down - If training with preset Time, Time will count down from preset to 00:00. • Each preset increment or decrement is 1 minute between 00:00 to 99:00.
SPEED	Displays the training speed. Range 0.0 ~ 99.9.
DISTANCE	<ul style="list-style-type: none"> • Accumulates total distance from 0.00 up to 99.99 KM or ML. The user may preset target distance data by using UP/DOWN button. • Each preset increment or decrement is 0.1KM or ML between 0.00 to 99.90.
CALORIES	Accumulates calories consumption during training from 0 to maximum 9999 calories (this data is a rough guide for comparison of different exercise sessions which can not be used in medical treatment).
PULSE	User may set up target pulse from 0 - 30 to 230; and computer buzzer will beep when actual heart rate is over the target value during workout.
RPM	Rotation per minute. Range 0 ~ 999.
WATT	Display current workout watts. Display range 0~999.
MANUAL	Manual training mode.
PROGRAM	Beginner, Advance and Sporty, 12 programs for selection.
CARDIO	Target HR training mode.
WATT PROGRAM	WATT constant training mode.

OPERATION

POWER ON

Plug in power supply, computer will power on and display all segments on LCD for 2 seconds (Drawing 1).

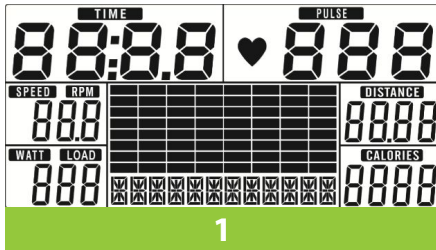

WORKOUT SELECTION

Use UP or DOWN (Encoder) to select workout Manual (Drawing 2) -> Beginner (Drawing 3) -> Advance (Drawing 4) -> Sporty (Drawing 5) -> Cardio (Drawing 6) -> Watt (Drawing 7).

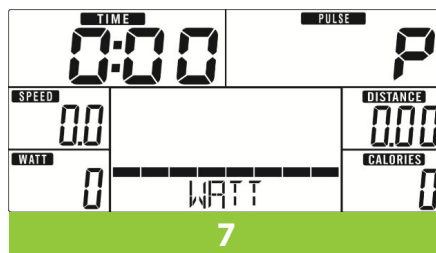
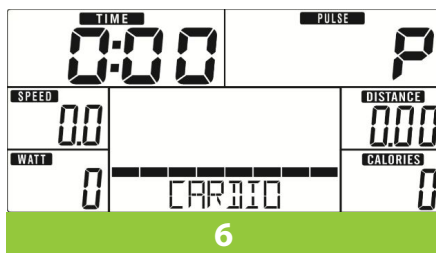
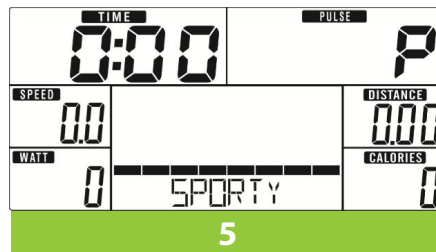
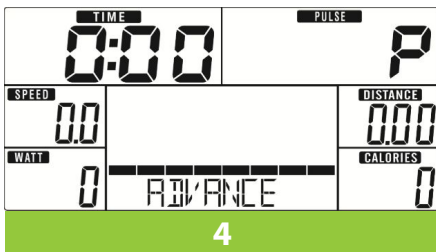
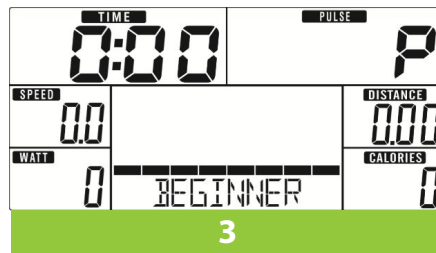
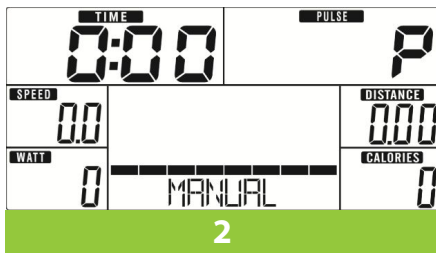

MANUAL MODE

Press START in main menu may start workout in manual mode.

1. Use UP or DOWN (Encoder) to select workout program, choose Manual and press MODE / ENTER to get into.
2. Use UP or DOWN (Encoder) to set TIME (Drawing 8), DISTANCE (Drawing 9), CALORIES (Drawing 10), PULSE (Drawing 11) and press MODE / ENTER to confirm.
3. Press START/STOP keys to start workout. Use UP or DOWN (Encoder) to adjust load level. Load level display in WATT window, no adjusting for 3s, it will switch to display WATT (Drawing 12).
4. Press START/STOP keys to pause workout. Press RESET to reverse to main menu.

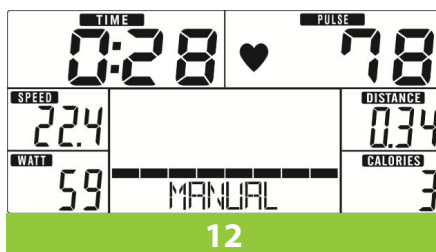
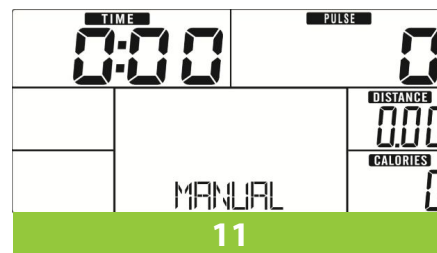
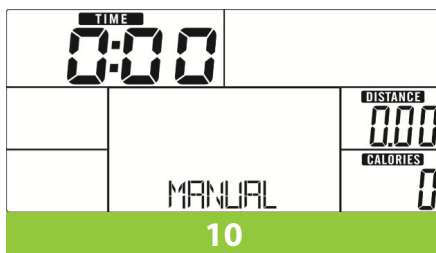
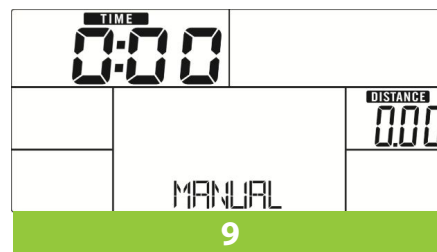
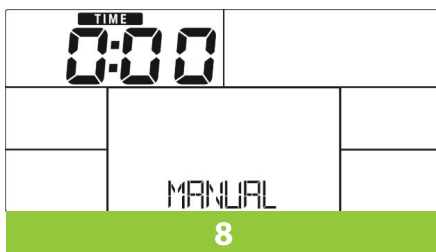

BEGINNER MODE

1. Use UP or DOWN (Encoder) to select workout program, choose Beginner mode and press MODE / ENTER to get into.
2. Use UP or DOWN (Encoder) to select Beginner program 1~4 (Drawing 13) and press MODE / ENTER to get into.
3. Use UP or DOWN (Encoder) to set TIME.
4. Press START/STOP key to start workout. Use UP or DOWN (Encoder) to adjust load level.
5. Press START/STOP key to pause workout. Use RESET to reverse to main menu.

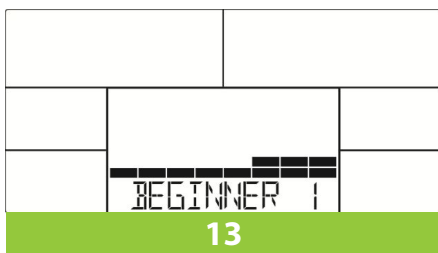

ADVANCE MODE

1. Use UP or DOWN (Encoder) to select workout program, choose Advance mode and press MODE / ENTER to get into.
2. Use UP or DOWN (Encoder) to select Advance program 1~4 (Drawing 14) and press MODE / ENTER to get into.
3. Use UP or DOWN (Encoder) to set TIME.
4. Press START/STOP key to start workout. Use UP or DOWN (Encoder) to adjust load level.
5. Press START/STOP key to pause workout. Use RESET to reverse to main menu.

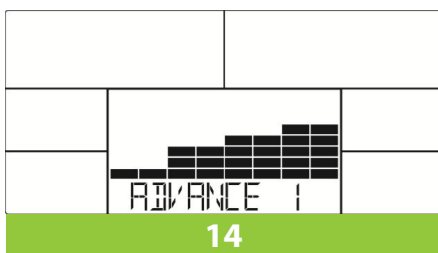

SPORTY MODE

1. Use UP or DOWN (Encoder) to select workout program, choose Sporty mode and press MODE / ENTER to get into.
2. Use UP or DOWN (Encoder) to select Sporty program 1~4 (Drawing 15) and press MODE / ENTER to get into.
3. Use UP or DOWN (Encoder) to set TIME.
4. Press START/STOP key to start workout. Use UP or DOWN (Encoder) to adjust load level.
5. Press START/STOP key to pause workout. Use RESET to reverse to main menu.

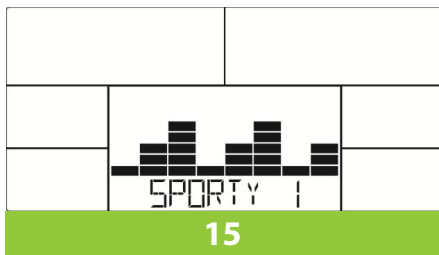

CARDIO MODE

1. Use UP or DOWN (Encoder) to select workout program, choose H.R.C. and press MODE / ENTER to get into.
2. Use UP or DOWN (Encoder) to set Age (Drawing 16).
3. Use UP or DOWN (Encoder) to select 55%.75%.90% or TAG (TARGET H.R.) (default: 100).
4. Use UP or DOWN (Encoder) to set workout TIME.
5. Press START/STOP key to start or stop workout. Use RESET to reverse to main menu.

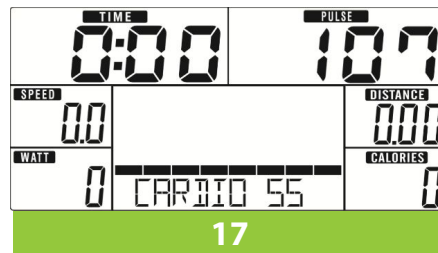
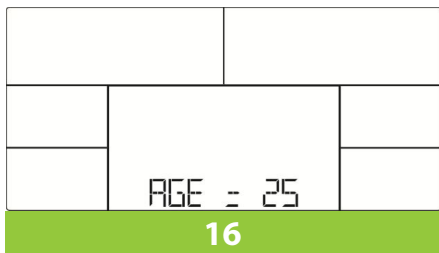

WATT MODE

1. Use UP or DOWN (Encoder) to select workout program, choose WATT and press MODE / ENTER to get into.
2. Use UP or DOWN (Encoder) to set WATT target. (default: 120, Drawing 18)
3. Use UP or DOWN (Encoder) to set TIME.
4. Press START/STOP key to start workout. Use UP or DOWN (Encoder) to adjustWatt level.
5. Press START/STOP key to pause workout. Use RESET to reverse to main menu.

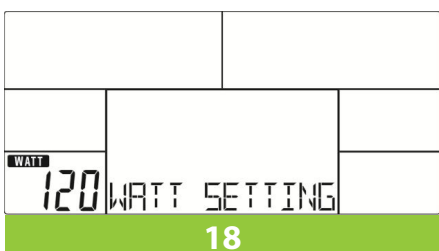

RECOVERY

After exercising for a period, keep holding on hand grips or wearing chest strap and press RECOVERY key. All function display will stop except "TIME" starts counting down from 00:60 to 00:00 (Drawing 19). Screen will display your heart rate recovery status with the F1, F2.... to F6. F1 is the best, F6 is the worst (Drawing

20). User may keep exercising to improve the heart rate recovery status. (Press the RECOVERY button again to return the main display).

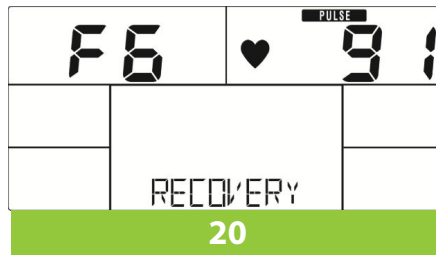
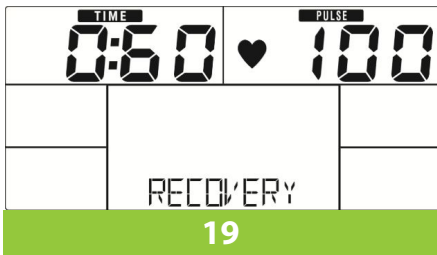

BODY FAT

1. In STOP mode, press the BODY FAT key to start body fat measurement.
2. Console will remind to input user GENDER (Drawing 21), AGE, HEIGHT, WEIGHT, then begin to measure.
3. During measuring, users have to hold both hands on the hand grips. And the LCD will display “= ”= ” (Drawing 22) for 8 seconds until computer finish measuring.
4. LCD will display BODY FAT advice symbol, BODY FAT percentage (Drawing 23), BMI (Drawing 24) for 30 seconds.
5. Error message:
 - * **The LCD displays “= ”= ”= ” (Drawing 25) – Not hand the grip or wear chest strap correctly.**
 - * **E-1 – There is no heart rate signal input detected.**
 - * **E-4 – Occurs when FAT% is below 5 or exceeds 50, BMI result is below 5 or exceeds 50 (Drawing 26).**

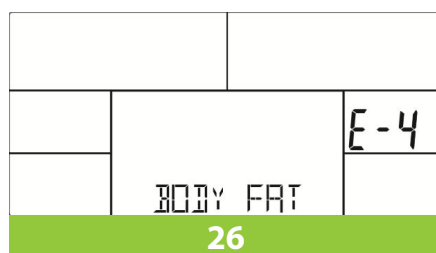
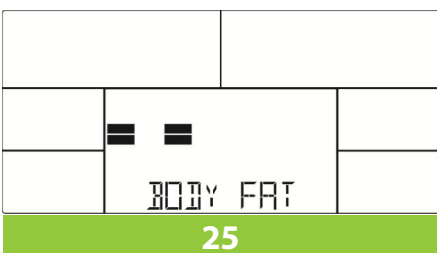
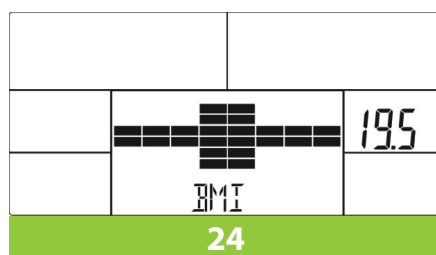
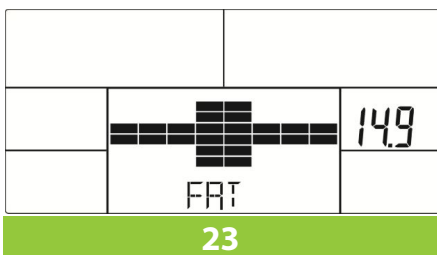
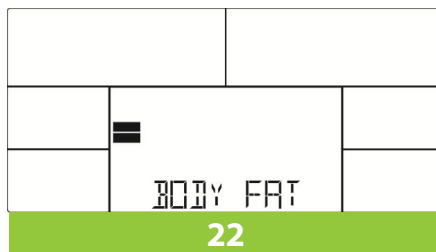
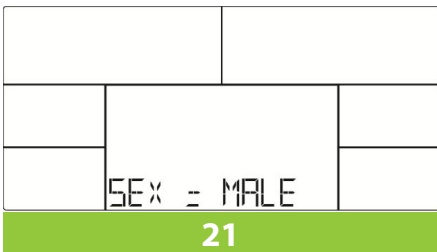

INSTRUCTION

1. QR code scanner app is required to scan the QR code with an Android or IOS phone or tablet. This app can be downloaded in the App Store or Google Play Store.
2. Scan one of the QR codes below to go directly to the place in the App Store or Google Play Store where the app is located and can be downloaded.
3. Scan the QR code on the right to go to the user manual of the app. The manual describes step by step how the app should be connected to the device, how the app works and what the options are.

ICONSOLE+

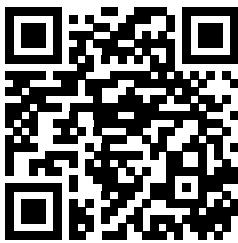

APP STORE
ICONSOLE+



GOOGLE PLAY
ICONSOLE+

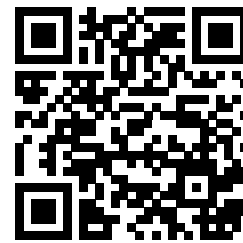

USER MANUAL
ICONSOLE+

KINOMAP

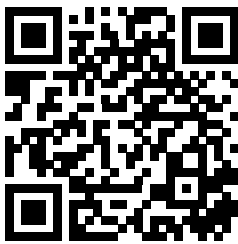

APP STORE
KINOMAP



GOOGLE PLAY
KINOMAP

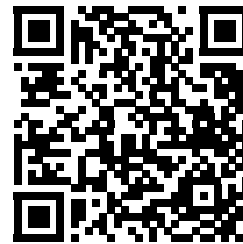

USER MANUAL
KINOMAP

VirtuFit does not provide service for third-party fitness apps such as Kinomap, iConsole, FitShow etc.. If you encounter any troubles with a third-party fitness app, please contact the app developer.

#	DESCRIPTION	QTY
1	Main Frame	1
2	Guide rail	1
3	Roller bracket	2
4	Handlebar post	1
5 L/R	Pedal bar	1 pr
6 L/R	Swing bar	1 pr
7 L/R	Handlebar	1 pr
8	End cap	2
9	Inner hexagon screw M8*16	10
10	Spring washer D8	12
11	Big flat washer	2
12	Plastic bushing	6
13	Cross screw M6*15	8
14	Aluminum track	4
15	Oval end cap	2
16	Aluminum cap	1
17	Ring	1
18	Dipping grip	1
19	Inner hex nut M5*4	2
20	Connecting axle	1
21	Cross screw M5*10	3
22	Handle cover	1
23	Handle	1
24	Nylon nut M8	1
25	Inner hexagon screw M5*30	1
26	Inner hexagon screw M8*25	1
27	Flat washer D8*D16*1.5	3
28	Nylon nut M8	3
29	Compressed spring	1
30	Plug	1

#	DESCRIPTION	QTY
31	Adjustable foot pad	3
32	Arc washer D8*D20*1.5, R20	6
33	Inner hexagon screw M10*45	2
34	Flat washer D10*D20*2	4
35	Nylon nut M10	2
36	Pedal	2
37	Washer D8*D30*2	4
38	Cross screw M6*20	10
39	Oval end cap	4
40	Adapter	1
41	Sensor wire	1
42	Universal joint	2
43	Inner hex screw M8*25	1
44	Extension wire	1
45 L/R	Handlebar cover	1 pr
46	Hexagon bolt M10*67	2
47	Hexagon bolt M10*25	1
48	Spring washer D10	3
49	Arc washer D10*D25*2, R28	1
50	Roller	2
51	Hexagon nut M12	2
52	Pulse wire	2
53	Round end cap	2
54	Hexagon bolt M8*35	2
55	Bushing	2
56 L/R	Pedal bar cover	2 pr
57 L/R	Swing bar cover	2 pr
58	Bearing	4
59	Bushing	4
60	Hexagon bolt M8*15	2

#	DESCRIPTION	QTY
61	Wave washer	2
62	Phillips tapping screw ST4.2*18	15
63	Console	1
64	Cross screw	4
65 _{L/R}	Handlebar cover	1
66	Grip	2
67	End cap	2
68	Connection tube cover	2

A successful exercise program consists of a warm-up, aerobic exercise, and a cool-down. Do the entire program at least two and preferably three times a week, resting for a day between workouts. After several months, you can increase your workouts to four or five times per week.

WARMING UP

The purpose of warming up is to prepare your body for exercise and to minimize injuries. Warm up for two to five minutes before strength-training or aerobic exercising. Perform activities that raise your heart rate and warm the working muscles. Activities may include brisk walking, jogging, jumping jacks, jump rope, and running in place.

STRETCHEN

Stretching while your muscles are warm after a proper warm-up and again after your strength or aerobic training session is very important. Muscles stretch more easily at these times because of their elevated temperature, which greatly reduces the risk of injury. Stretches should be held for 15 to 30 seconds.

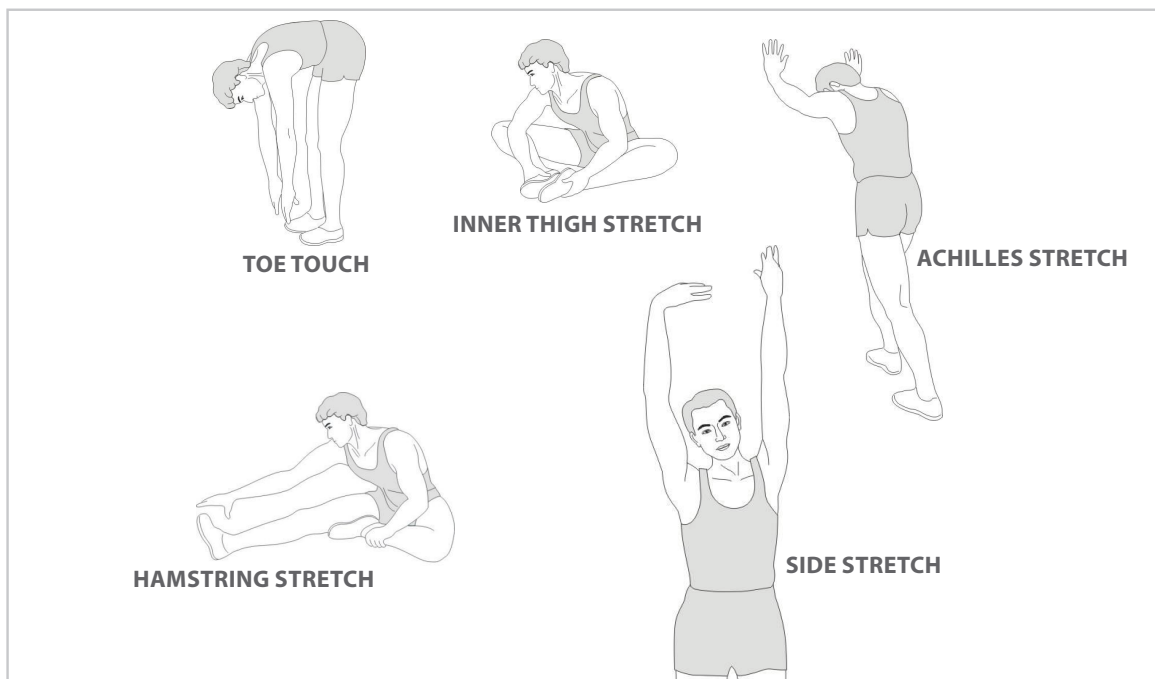

COOLING DOWN

The purpose of cooling down is to return the body to its normal or near normal, resting state at the end of each exercise session. A proper cool-down slowly lowers your heart rate and allows blood to return to the heart.

virtu profit

For questions or missing parts please contact your dealer.