

virtu^{fit}

Premium Trampoline Inground with Safety Net

User manual

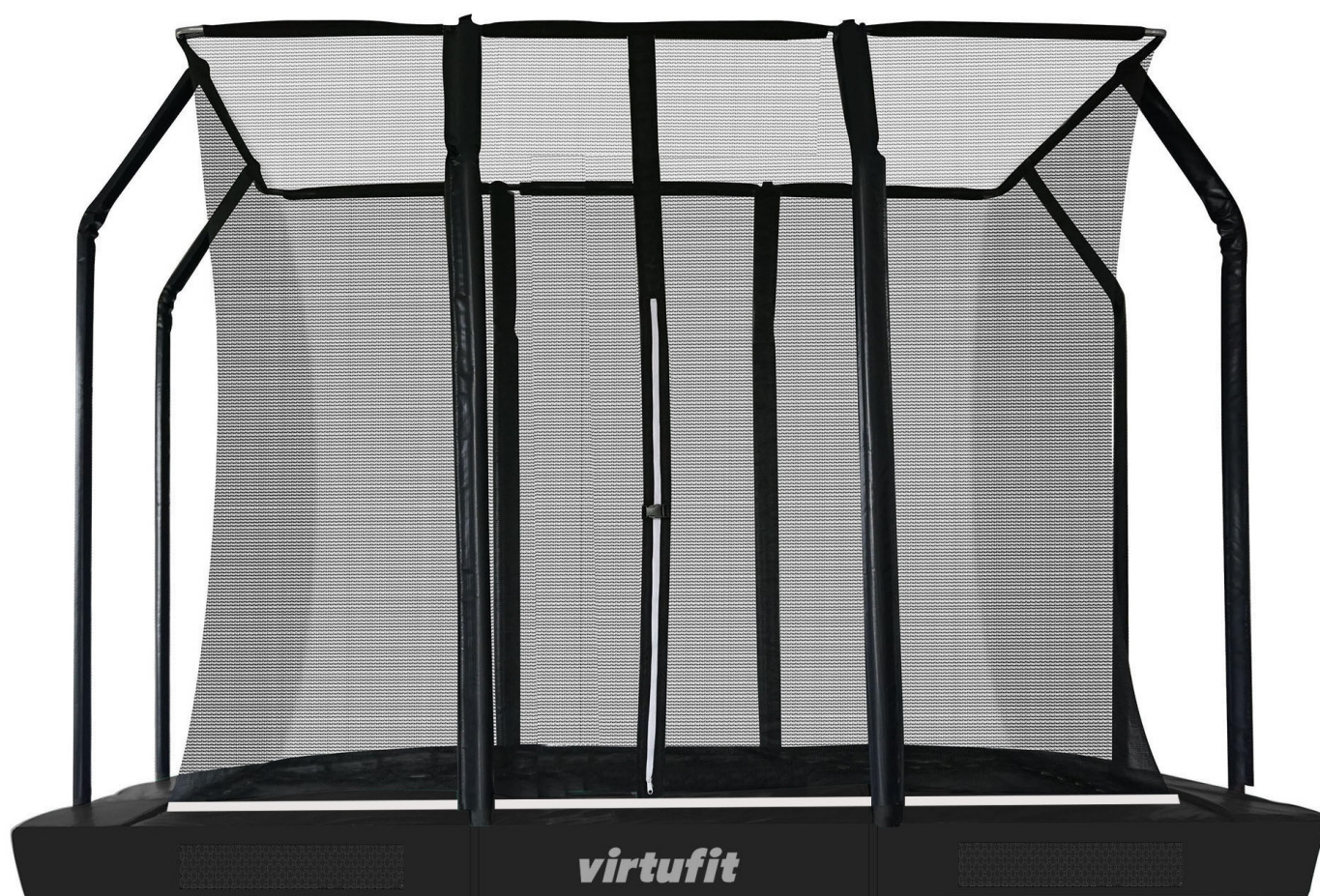

EN

SAFETY INSTRUCTIONS	3 - 5
CHECKLIST	6 - 7
ASSEMBLY INSTRUCTIONS	8 - 14
MOVING THE TRAMPOLINE	15
MAINTENANCE	16
BASIC TRAMPOLINE SKILLS	17

WARNING:

Consult your child's doctor before jumping, especially for children with health problems. Read all instructions before using the trampoline. VirtuFit takes no responsibility for any injuries or material damage caused by the use of this product. Read the manual carefully before you start to assemble and/or use the trampoline. Adult supervision is required at all times.

ATTENTION

- Recommended age 6+ years. Not suitable for children under 36 months - small parts, choking hazard.
- No somersaults or flips - can cause serious injury. Jump without shoes.
- Only for domestic use. The trampoline is intended for outdoor use only.
- Only one user at a time. Danger of Collision hazard.
- Always close the net opening before jumping.
- Do not use the mat when it is wet
- Always jump in the middle of the mat. Empty pockets and hands before jumping
- Do not eat while jumping. It is advisable not to bounce immediately after a meal.
- Do not exit by a jump
- Do not use in strong wind conditions and secure the trampoline.
- The trampoline shall be assembled by an adult in accordance with the assembly instructions and thereafter checked before the first use.
- Installation of the trampoline requires a hole to be dug in the ground. If you are not sure about the ground work, please contact a professional.
- The hole should not accumulate water (so drainage is necessary) and it should be possible to clean during maintenance.
- Enter and exit the trampoline only at the opening in the safety net designated for that purpose.

- The max user weight is: 183x274x200: 150 KGS - 214x305x200: 150 KGS - 244x366x200: 150 KGS.

ADVISORY

- Limit the time of continuous usage (make regular stops).
- This trampoline is not intended to be buried in the ground.
- The trampoline must be placed on a level surface at least 2m from any structures or obstructions such as fence, garage, house, overhanging branches, laundry lines or electrical wires.
- Do not install the trampoline over concrete, asphalt or any other hard surface. Also not in proximity of other conflicting installations, such as padding / swimming pools, swings, slides or climbing frames.
- Any modifications made by the consumer to the original trampoline (e.g. the adding of an accessory) shall be carried out according to the instructions of the manufacturer.
- Inspect trampoline / enclosure net before each use.
- If an access ladder is used it should be removed when trampoline is not in use.
- Make sure there are no children / animals / obstructions underneath the trampoline.
- Access the trampoline through the door of the enclosure net only. Making sure you securely close it before bouncing. Use: Ensure the door is securely closed before bouncing.
- Don't intentionally rebound off the enclosure net as this will weaken it.
- Only attach manufacturer approved accessories to the trampoline and enclosure net.
- Always jump in the middle of the mat and practice bounce techniques safely with adult supervision and guidance.

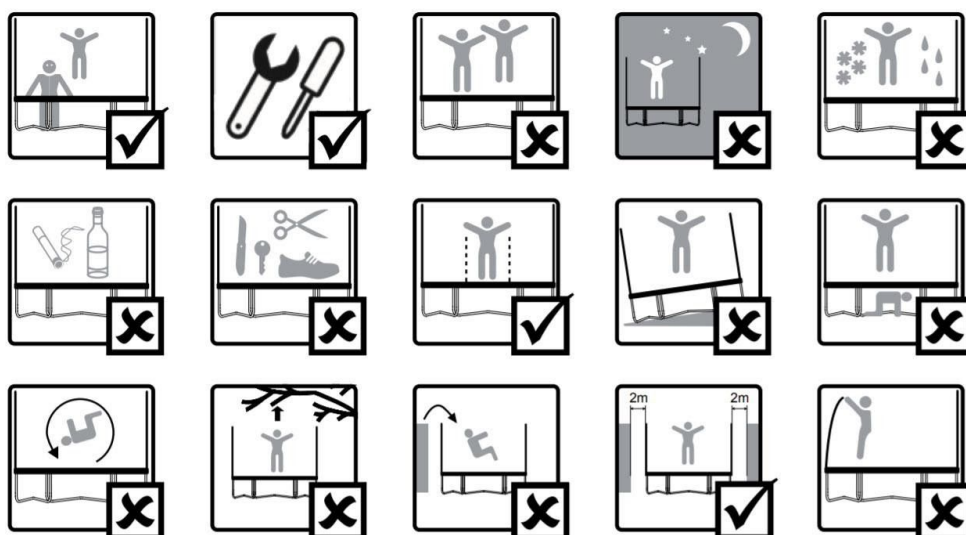

Warranty claim is excluded if the cause of the defect is the result of:

- Maintenance assembly and repair work not performed by an official dealer.
- In case of improper use, neglect and / or poor maintenance.
- Failure to maintain the fitness equipment in accordance with the manufacturer's instructions.
- The product has been incorporated into the soil.
- Defects caused by external influences (eg climate and weather influences).









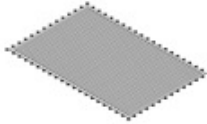

ASSEMBLY AND MAINTENANCE INSTRUCTIONS

- Attention to the need to carry out checks and maintenance of the main parts (frame, suspension system, mat, padding, and enclosure) at the beginning of each season and also at regular intervals of every 2 weeks, pointing out that if these checks are not carried out, the trampoline could become dangerous.
- Check all nuts and bolts for tightness and tighten when required.
- Check that all spring-loaded (pit pin) joints are still intact and cannot become dislodged during play.
- Check all coverings and sharp edges and replace when required.
- Retain the maintenance instruction manual.
- Outdoor trampolines should be equipped with a device that in strong wind conditions avoid displacement due to wind (e.g. steel bars in the ground or loads like sand bag or water bags) and/or items catching wind like net and mat should be removed.
- In certain countries during winter period, the snow load and the very low temperature can damage the trampoline. It is recommended to remove the snow and store the mat and the enclosure indoor.
- Check that mat, padding, enclosure and soft surface are without defects.
- Make sure that the hook-and-loop fasteners are closed correctly during use of trampoline!
- Trampoline and net should be packed away in winter. Make sure all parts are dry and packed securely.
- Store dry to support product longevity. Always be aware of wear and tear due to weather and wind.
- We recommend securing the trampoline in strong winds. Tie the trampoline down with ropes attached to the trampoline pad. Tie the trampoline down in a minimum of three places distributed evenly across the trampoline frame.
- Do not secure the legs as these may become misaligned and ruin the trampoline. Dismantle or remove the trampoline completely, if required. It may result in great danger if the trampoline is not secured in strong winds.
- If the trampoline is not used for short periods of time and to avoid jump mat debris caused by fallen leaves and twigs, It's recommended usage of a Weather Cover. When the trampoline is not used for a longer period of time (e.g. during the winter). It's recommended storing the trampoline, especially the protective padding, in a dry area to support product longevity.
- Ensure that all parts are all correctly fixated together. Also, check if the trampoline has the same distance from the hole as instructed before entering into the trampoline.









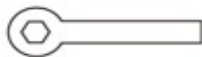

NOTE! *Sunlight, rain, snow and extreme temperatures reduce the strength of these parts over time.*

TOOLKIT



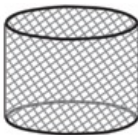

When you open the carton, and you will find the below parts in the carton. Place all parts on the floor. Make sure you have all the parts listed. If parts are missing, please contact the supplier.

#	DESCRIPTION		183*274 CM	214*305 CM	244*366 CM
A	Jumping Mat		1	1	1
B	Frame pad		1	1	1
C	Frame Tube C		2	2	2
D	Frame Tube D		2	2	2
E	Corner frame tube right		2	2	2
F	Corner frame tube left		2	2	2
G	T-connector		8	8	8
H	Leg Tube H		2	2	2
I	Leg Tube I		2	2	2
J	L Anchor Kits		8	8	8

TOOLKIT

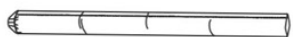
#	DESCRIPTION		183*274 CM	214*305 CM	244*366 CM
K	Spanner		1	1	1
L	Spring		48	52	64
M	U Anchor Kits		8	8	8
N	Spring Tool		1	1	1
O	Bottom Pole Tube		8	8	8
P	Upper Pole Tube		8	8	8
Q	Enclosure Net		1	1	1
R	Cord		1	1	1
S	Screw		16	16	16
T	Pole Cap		8	8	8

TOOLKIT

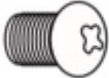
#	DESCRIPTION		183*274 CM	214*305 CM	244*366 CM
U	Screwdriver		1	1	1
V	PVC Sleeve		8	8	8
W	Fiberglass rod W		4	4	6
X	Fiberglass rod X		4	4	4
Y	Corner connector for fiberglass rods		4	4	4
Z	Flat screw		8	8	8

Missing parts: If you think you are missing certain parts in your package, carefully check the styrofoam and the trampoline. Some parts (bolts, screws, etc.) are already attached to/in the trampoline.

Use gloves to protect your hands from bottlenecks during assembly. When you're ready to get started, make sure you have plenty of room and a clean, dry area for mounting.

Read the assembly instructions below before you start mounting the trampoline. Incorrect mounting will damage the trampoline frame:

- Make sure the trampoline is placed on level ground. Uneven ground surfaces may cause the trampoline frame to warp (FIG 1).
- Make sure that all bolts holding the frame joints are tightened completely before installing the springs. Failure to do this properly will cause the frame to warp.
- Make sure NOT to use one's leg to push against the trampoline leg or frame when loading the springs. It will cause the trampoline to warp (FIG 2).
- DO NOT load the springs onto the frame on only one side of the trampoline. Uneven distribution of tension from the springs will cause the frame to warp (FIG 2).
- If the trampoline frame warps up, do not be alarmed as the "Quad-lock" system is designed to be flexible. Push down on the part of the frame that warped with two people as shown. The frame will level out (FIG 3).

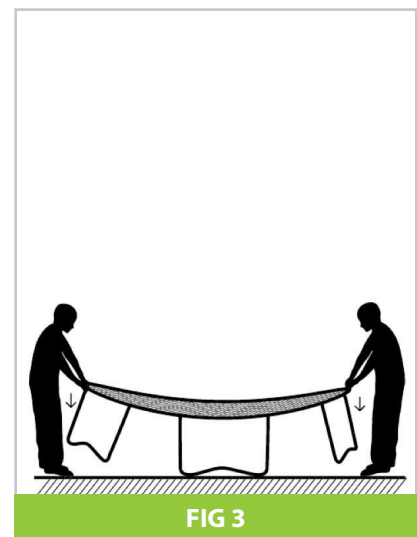
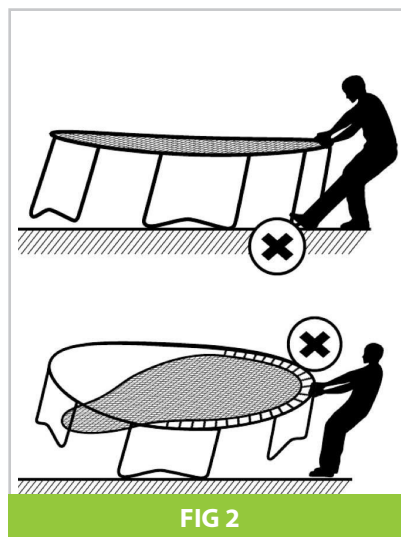
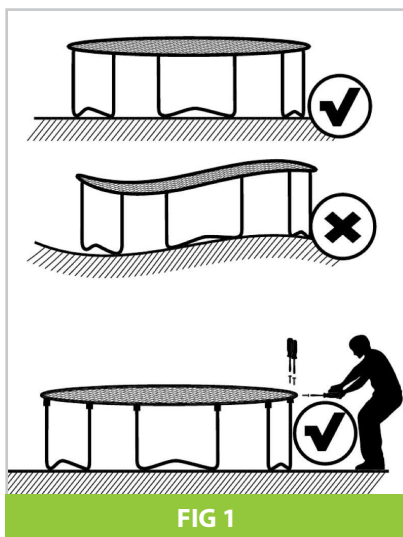

NOTE! For the next assembly 2 adults in good physical condition are required. Wear good shoes and keep balance to avoid a fall. Failure to follow all instructions and warnings exactly could result in serious injury.

STEP 1

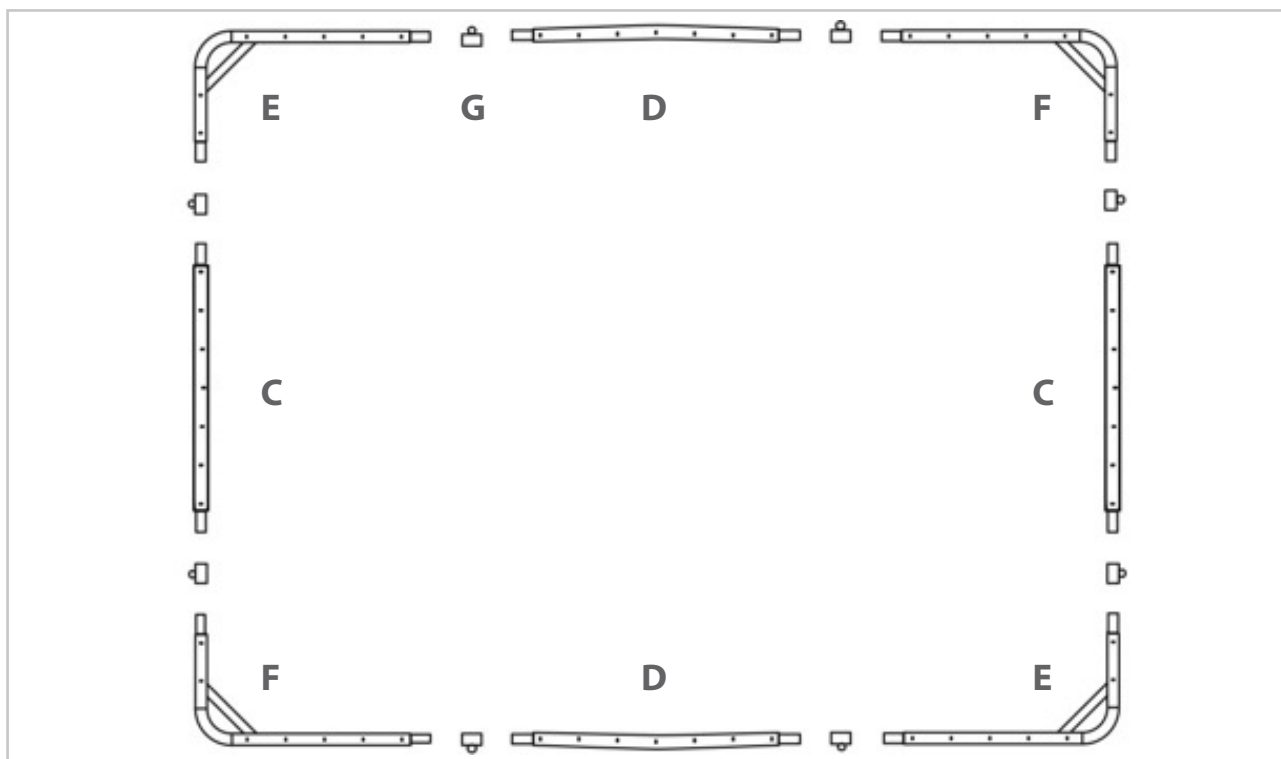

- Lay out all the trampoline parts in groups, as shown in the picture. Then begin by attaching all Frame Tubes (C, D, E, F) together. Position the T connectors (G) towards the right direction as shown in the image.

STEP 2

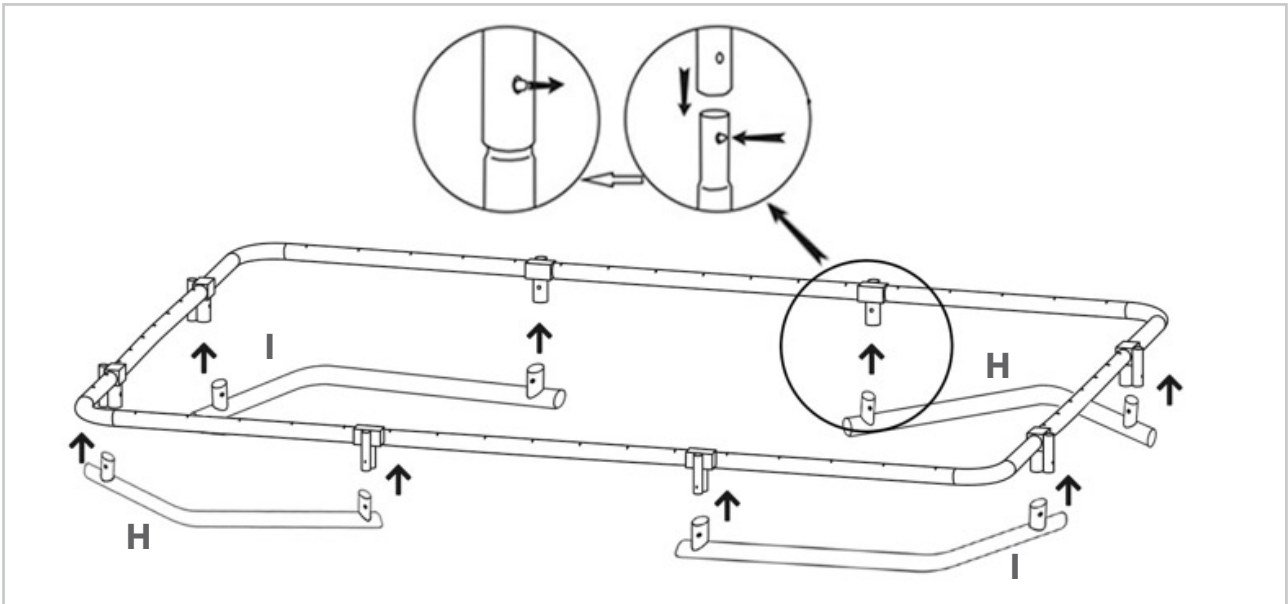

- Attach the Leg Tubes to the Frame Tubes. Frame tubes must be firmly inside the legs tube. Making sure the quick snap clicks on the leg tubes out through the hole on the T connectors, and towards the inside of the frame tube.

STEP 3 - DIG HOLE

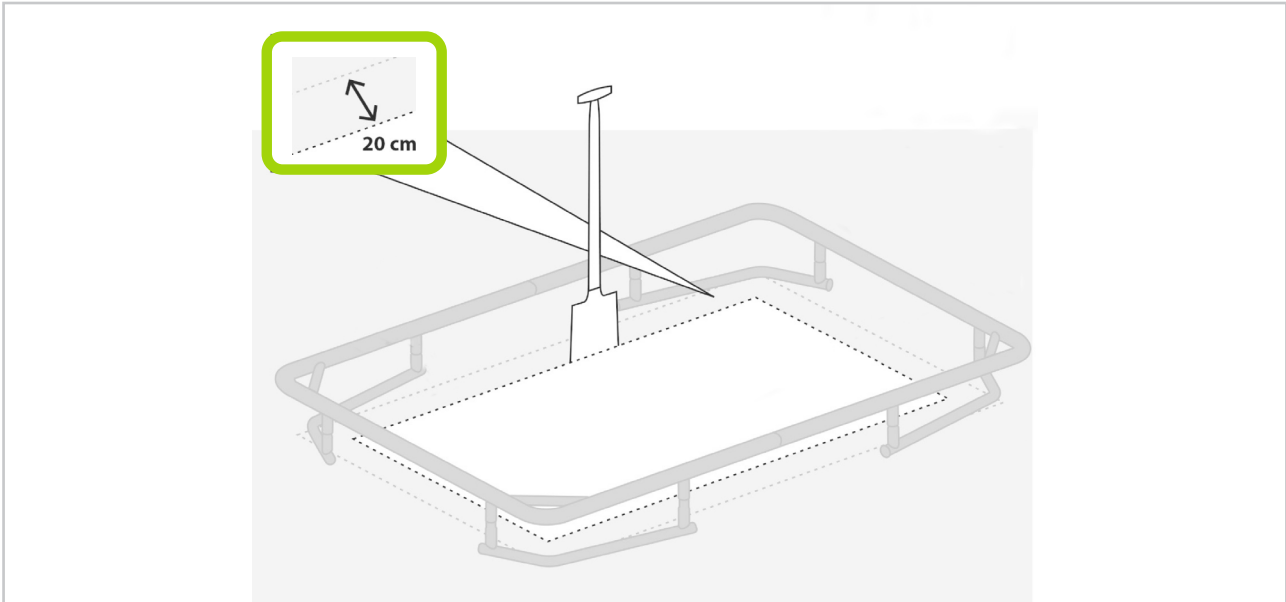

- Mark the line for the hole on the lawn as shown on picture above.

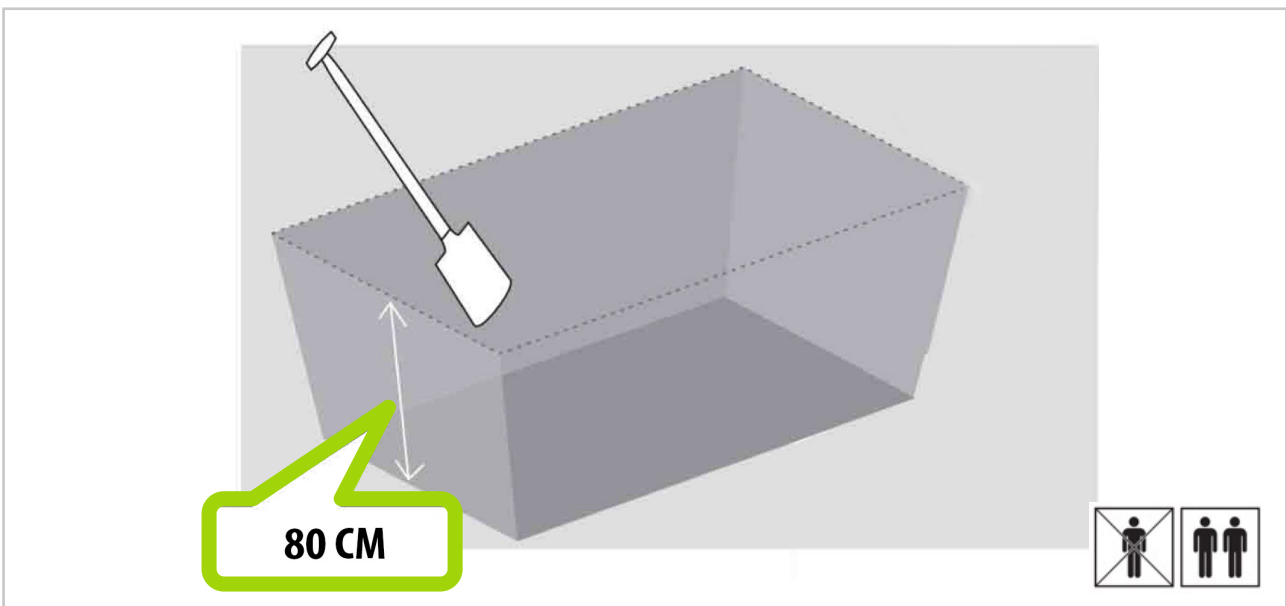

- Move the trampoline away and dig the hole as shown on picture above.
- When moving the trampoline, two people should be used. When moving, lift the trampoline slightly off the ground and keep it horizontal to the ground. For any type of other move, you should disassemble the trampoline.

NOTE! The hole should not accumulate water (so drainage is necessary) and it should be possible to clean during maintenance.

STEP 4

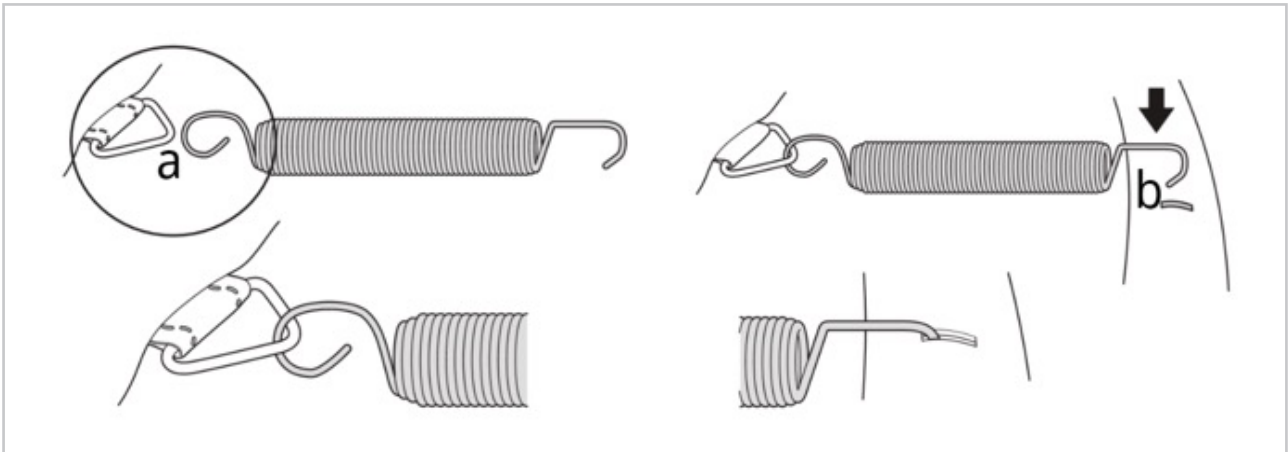

- Take Spring (L) and insert end 'b' into Top Rail tube, then put end 'a' of spring into trampoline Jumping Mat(A) rings.

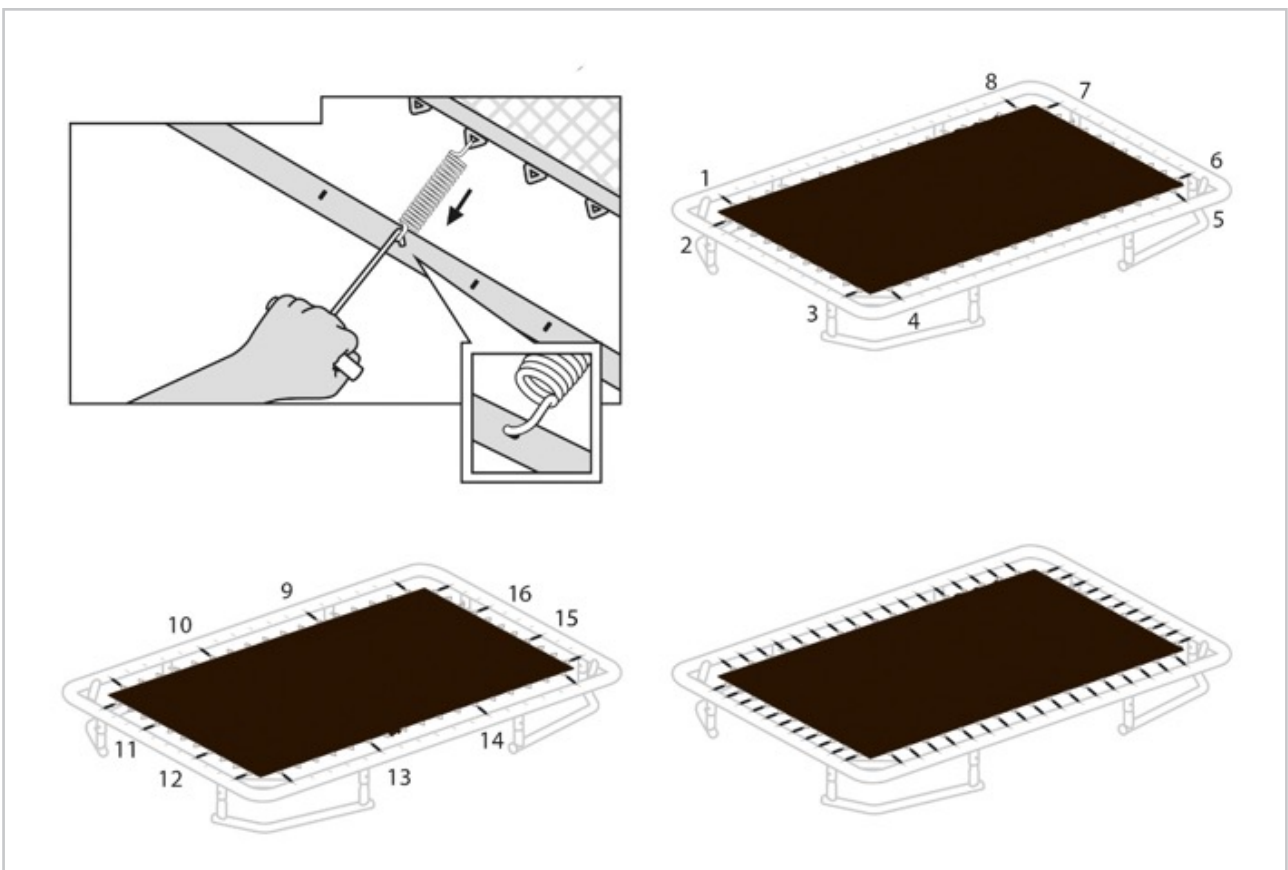

- Use 2 Springs in each corner, 2 springs equally spaced along each edge. This will equalize the mat. Then assemble remaining springs till all springs are placed depending the quantity of springs.

STEP 5

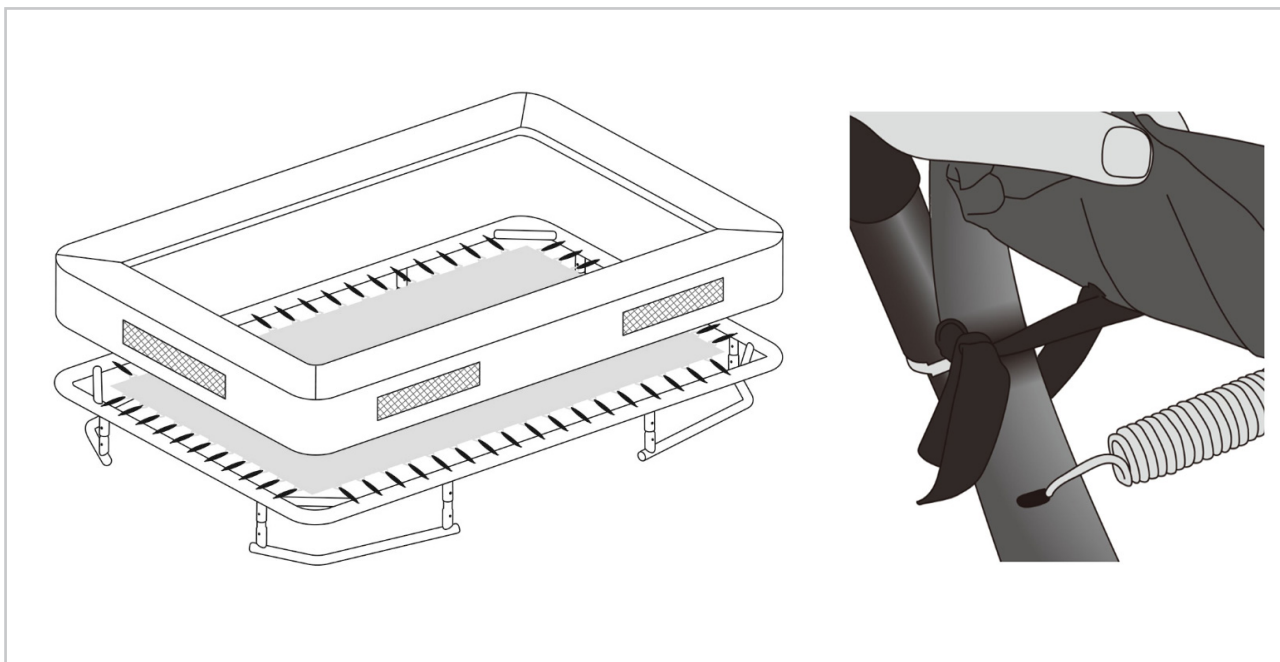

- Lay the Frame Pad (B) over the trampoline so that the springs and the steel frame is covered. Please ensure that the Frame Pad covers all metal parts.
- Tie the strap located at the under the side of the pad to the frame.

STEP 6 - SAFETY NET

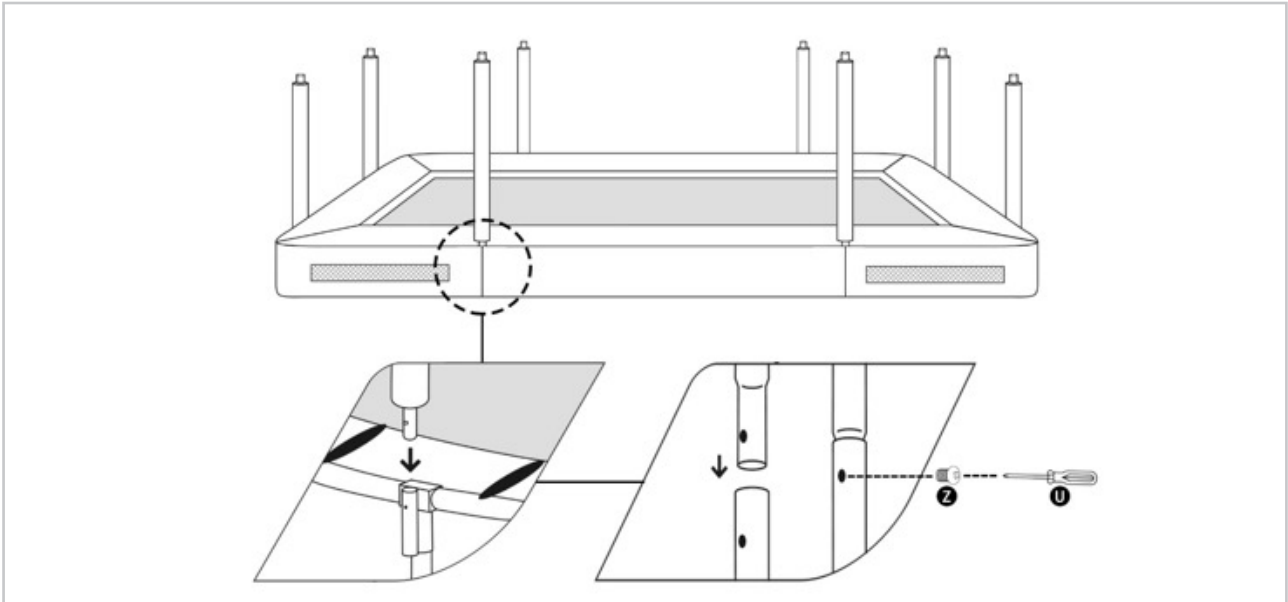

- Insert the bottom pole tubes (O) into the tube that welded on the T connectors. Make sure the hole on the bottom pole tube aligns with the hole on the T connectors' welded tube, fasten with flat screw (Z) using the screwdriver (U).

STEP 7

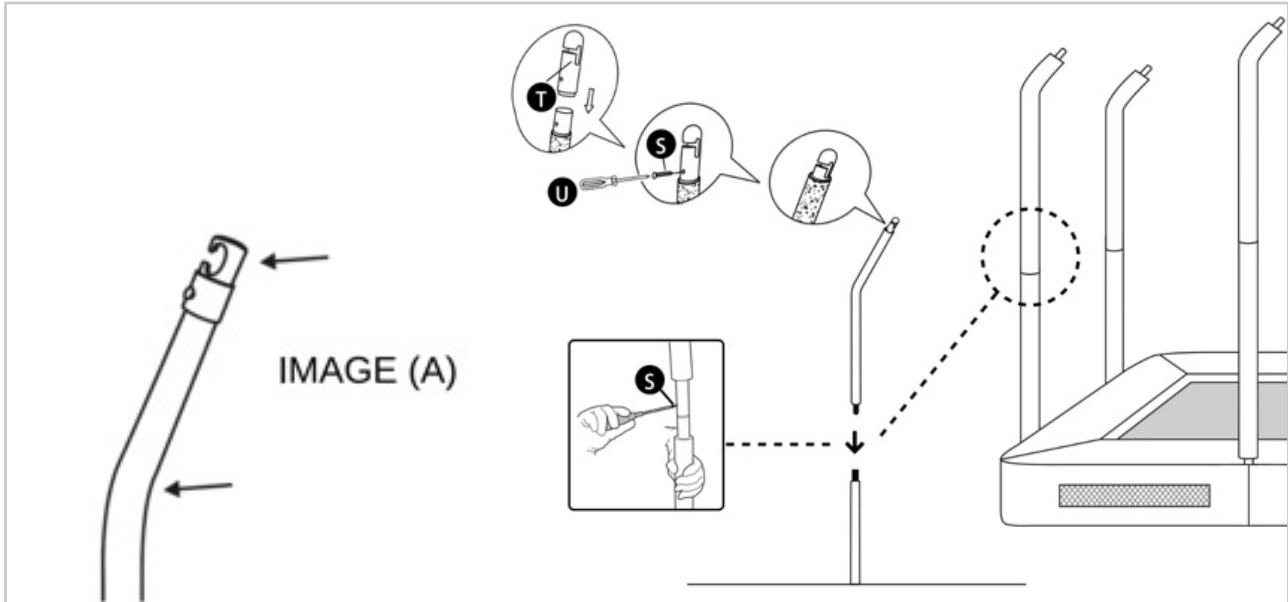

- Attach the pole caps (T) to the top of the upper pole tube (P), fasten with the screws (S) by screwdriver (U).
- Insert the upper pole tube (P) into the bottom pole tube (O). Align the holes in the bottom pole tube with the hole in the upper pole tube, then fasten with the screw (S) by using the screwdriver provided (U).

STEP 8



- Slide the PVC sleeves (V) onto the assembled enclosure poles.

STEP 9

- Lay out and position the fiberglass rods (W & X) and corner connectors (Y) as below according to your trampoline size.

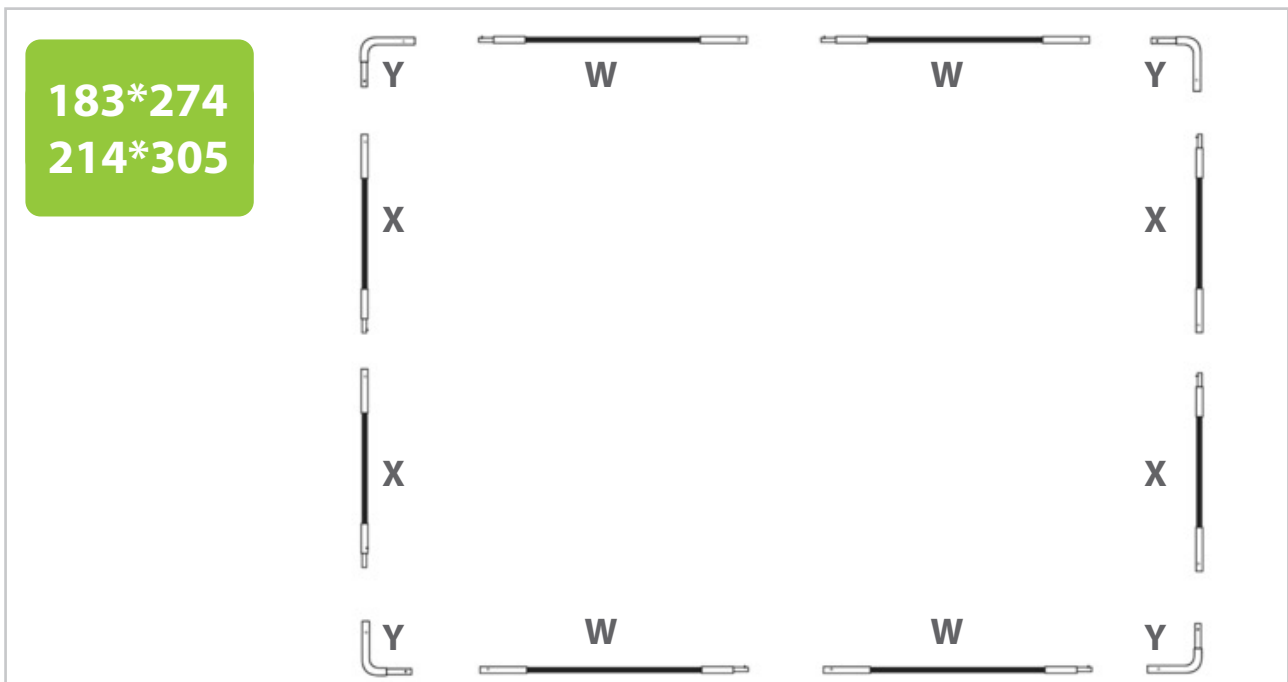
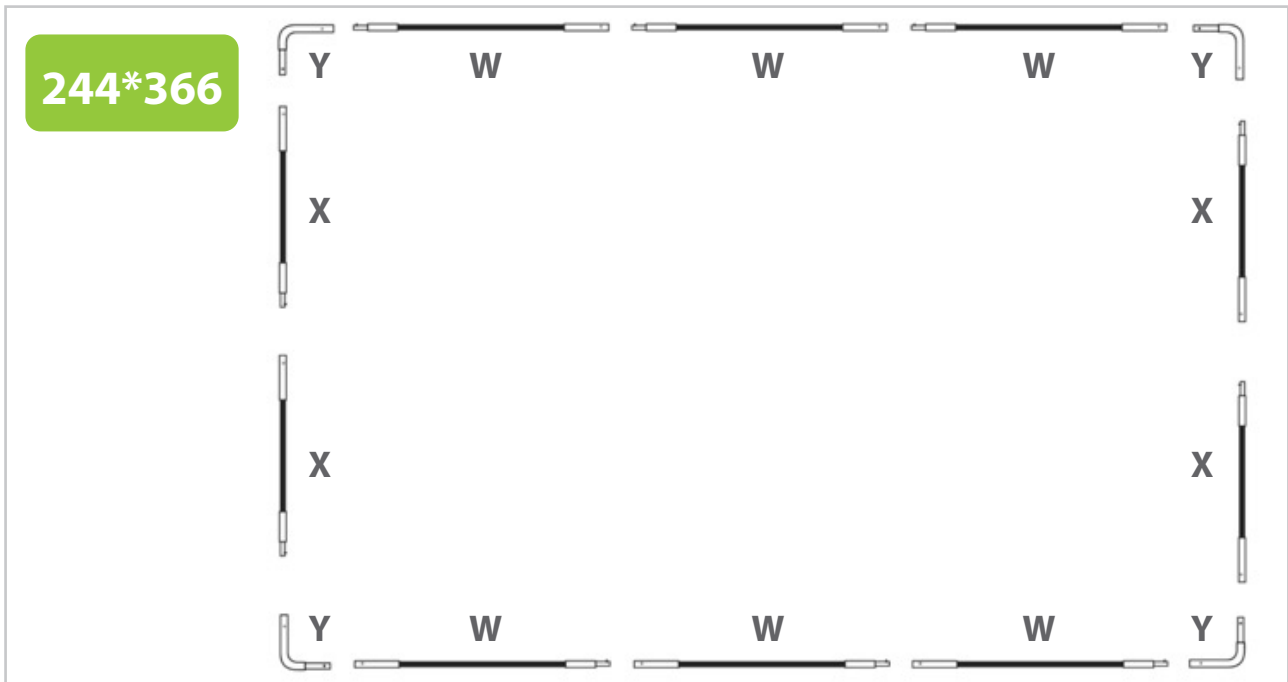

STEP 10

- Attach fiberglass rods W to make the long fiberglass rods, and fiberglass rods X to make the short fiberglass rods. After assembled, there should be 2 long fiberglass rods for the long sides of trampoline and 2 short fiberglass rods for the short side of trampoline.

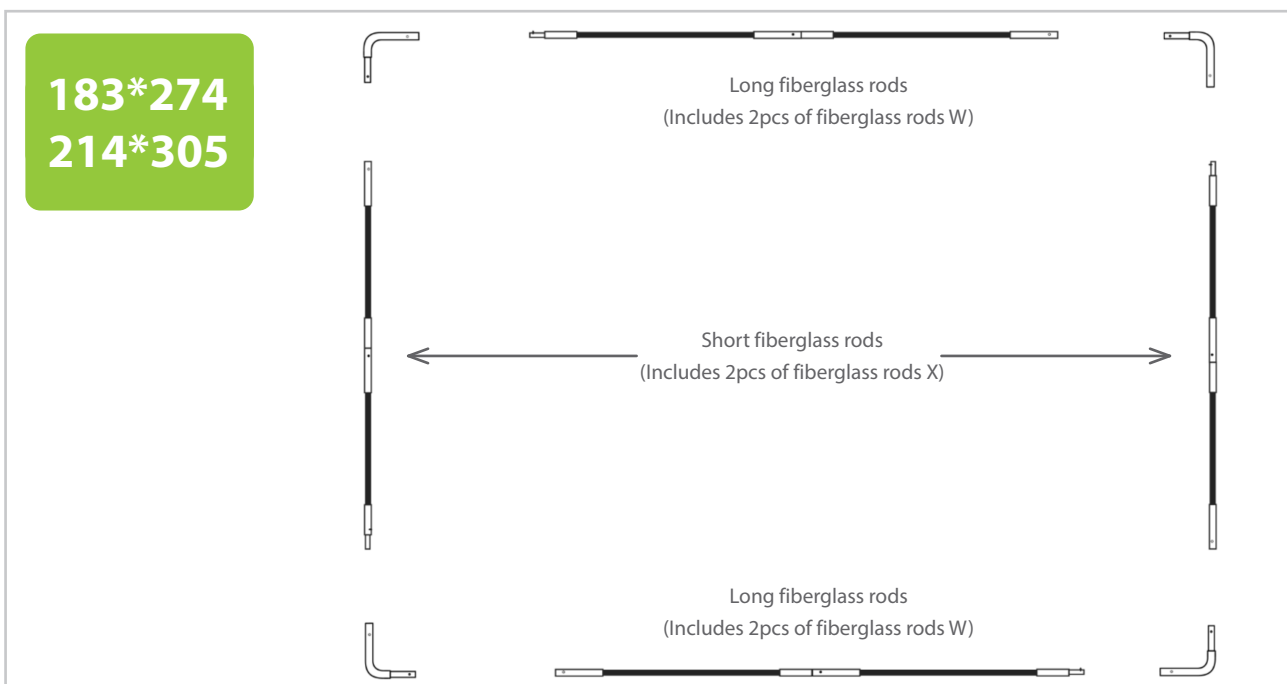
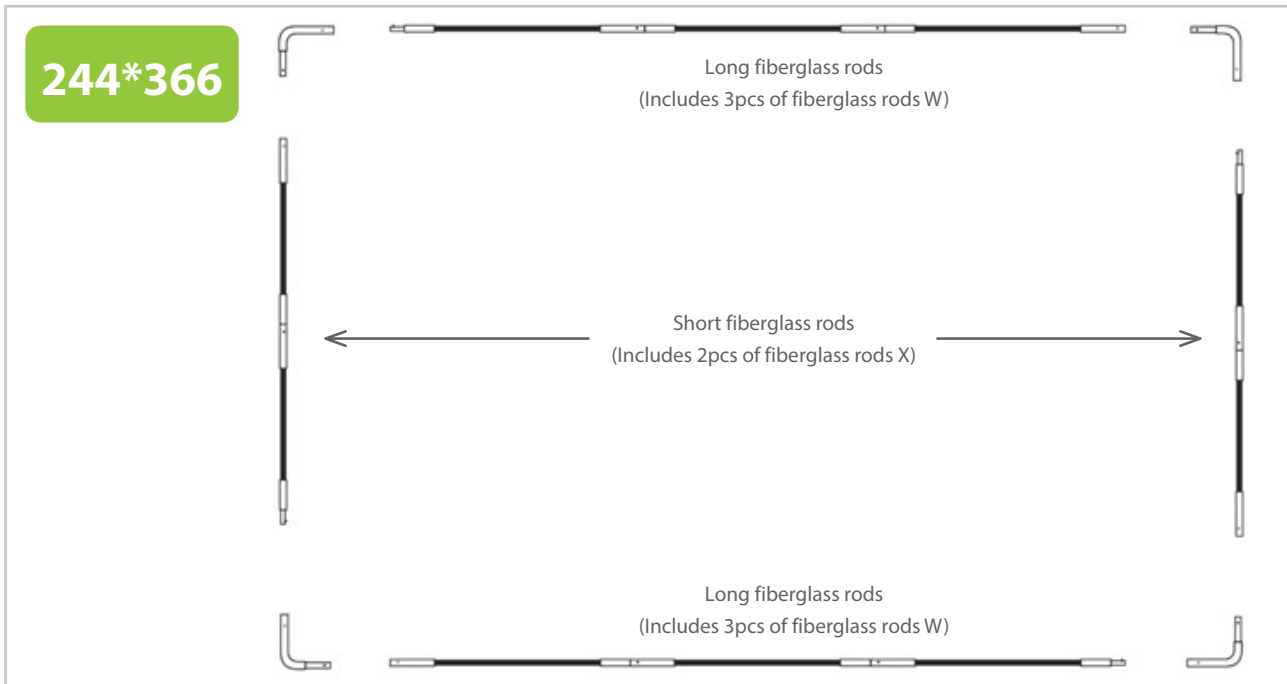

STEP 11

- Lay the safety net (Q) on the trampoline bed. Start insert the assembled fiberglass rods into the sewn sleeves on the top of safety net from the front right hand corner, where the white label is. The long fiberglass rods for long sides of trampoline and short fiberglass rods for short side of trampoline.

NOTE! Make sure that the zipper entrance is placed in the middle of the long side of the trampoline. Align the zipper with the logo on the pad.

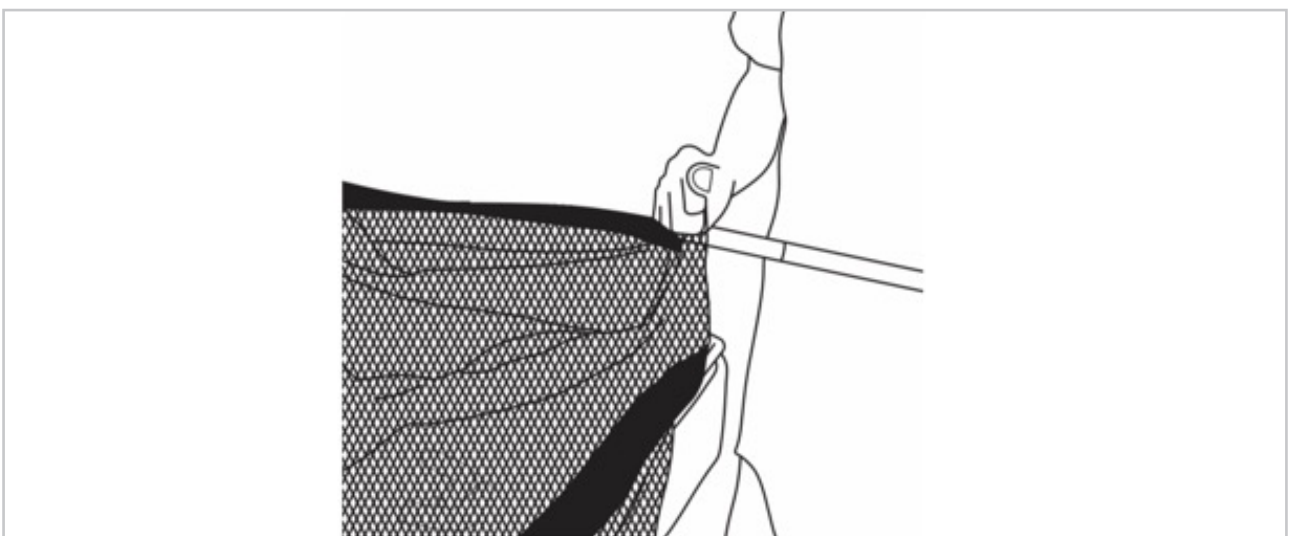
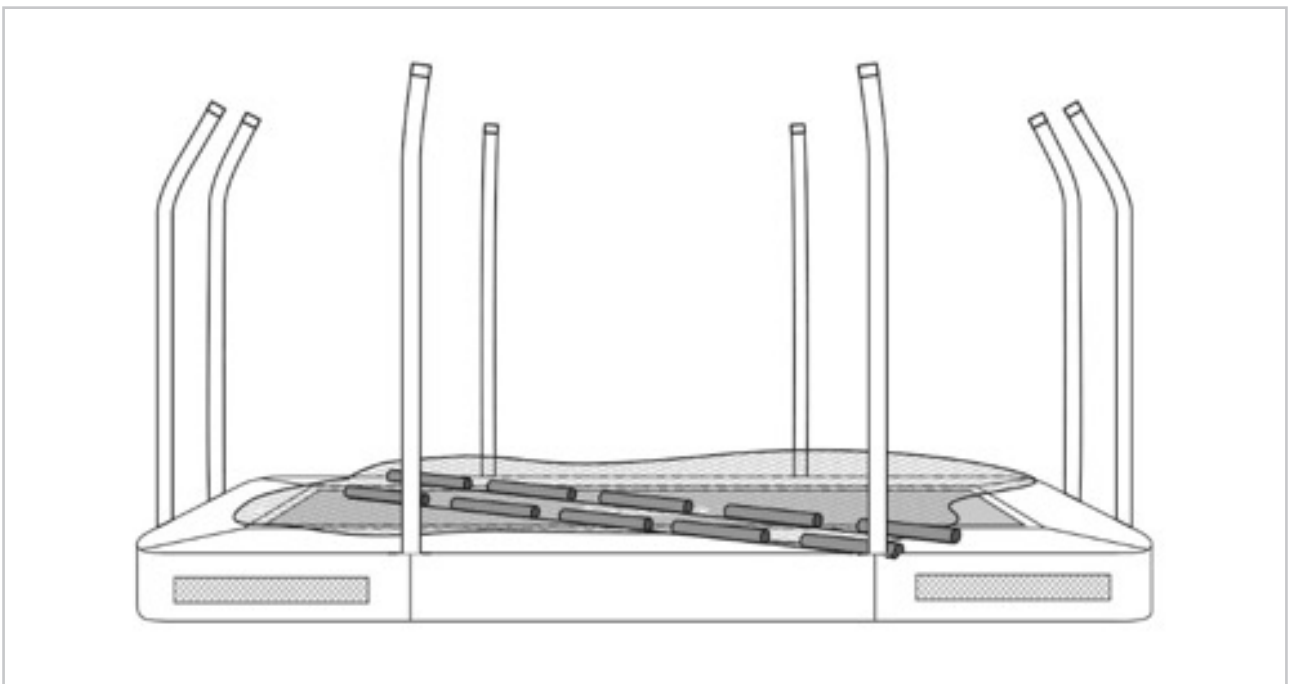

STEP 12

- After inserting the fiberglass rods into the safety net both the long sides and short sides, connect the short side to the long side with the corner connectors (Y). Push buttons need to be inserted into the corner pieces. Press the top of the push buttons together and push in all the way to the end of the corner piece, making sure that the buttons pop out through the holes.



STEP 13

- Raise the net up and connect the fiberglass rods to the top of the poles by clicking it into the pole caps (T).



STEP 14

- Connect the Velcro straps at the top of the PVC sleeves at the top of the pole caps.

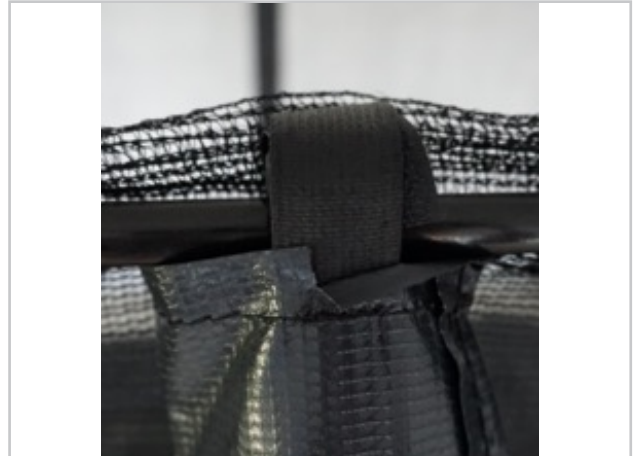

STEP 15

Install the bottom of enclosure net to the jumping mat as below 3 steps.

- Locate the D-ring closest to the door of the net. Thread one end of the cord (R) through the lower eyelet of the enclosure net above the D-ring and then thread the cord through the D-ring. Tie the enclosure net to the D-ring, by making a double knot in the cord.
- Thread the cord through the lower eyelet of the enclosure net halfway between the first D-ring and the D-ring to right, then thread the cord through to the right. Repeat this procedure until the cord are threaded through the enclosure net.
- Tie the cord to the last D-ring that is reaches. Make sure that the enclosure net is attached to every D-ring on the trampoline mat.

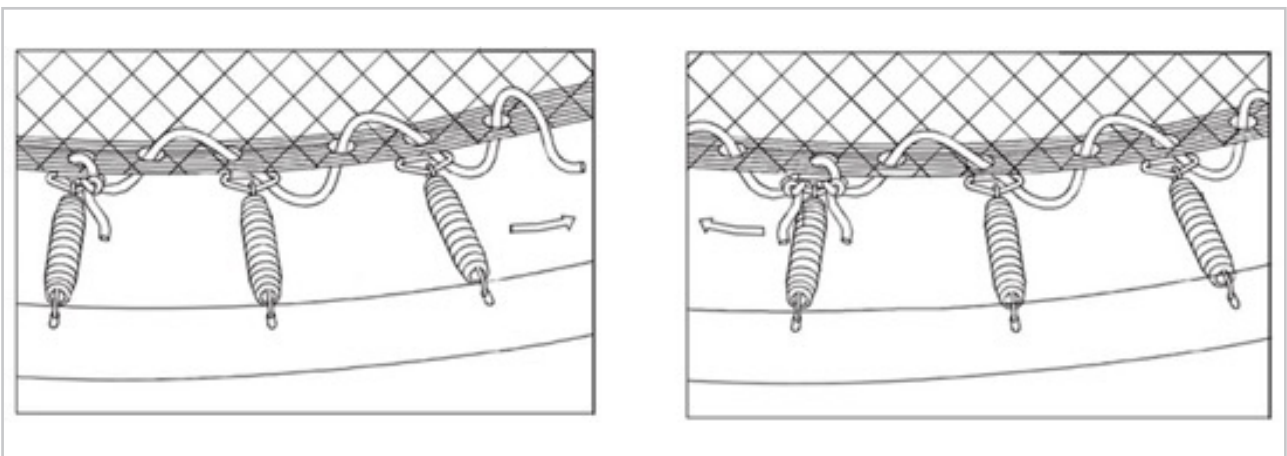

STEP 16

- The white label that sews on the top of the safety net will be positioned on the front right hand corner as below image shown. If not, then please check and re-install the safety net.

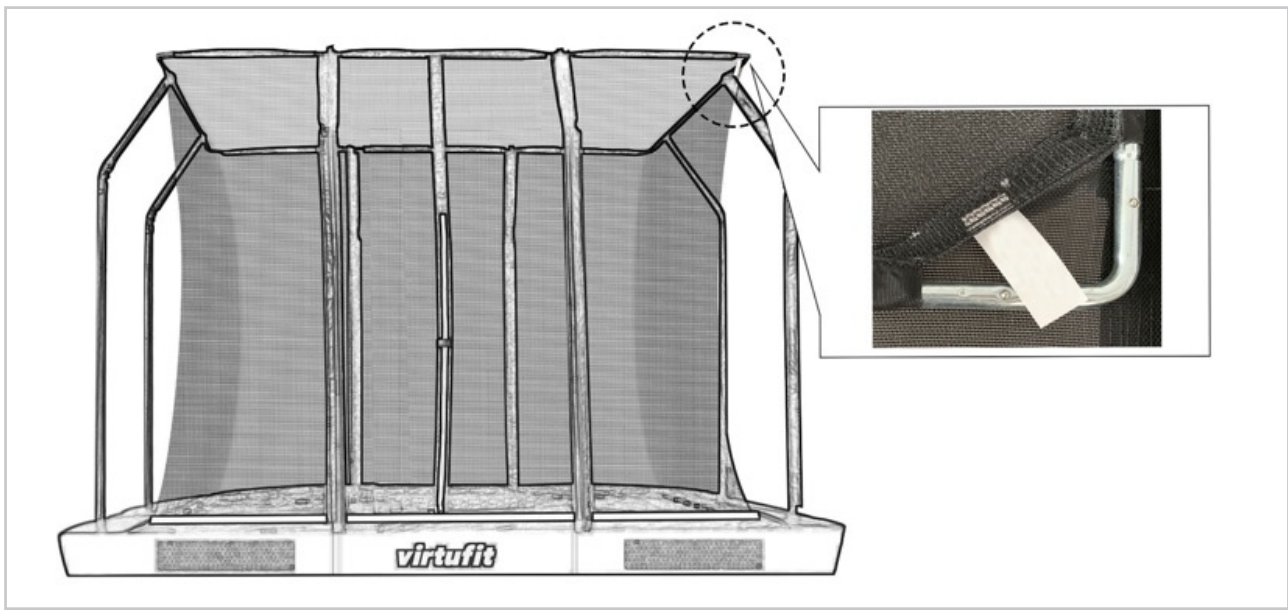

STEP 17

- Before moving the trampoline above the hole, please double-check the condition inside the hole. Make sure there is no sharp stone inside the hole, and the hole is sturdy, etc. The moving should proceed after the safety of the hole is confirmed. If you are not sure about the ground work or hole, please contact a professional.
- Moving the trampoline above the hole. Two people should be used at least, four people is best. When moving, lift the trampoline slightly off the ground and keep it horizontal to the ground.

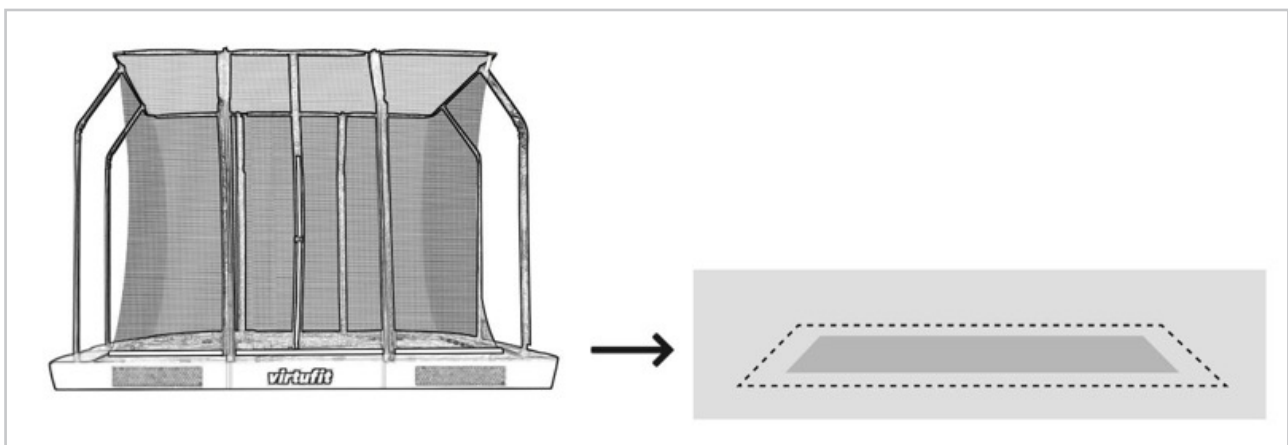

STEP 18

- Attached 2 pieces of U anchor kits (M) to each leg tube, assembly the remaining anchor kits to all leg tubes.
- Finally, attached the L anchor kits (J) to the hook that sewn on the edge of pad.

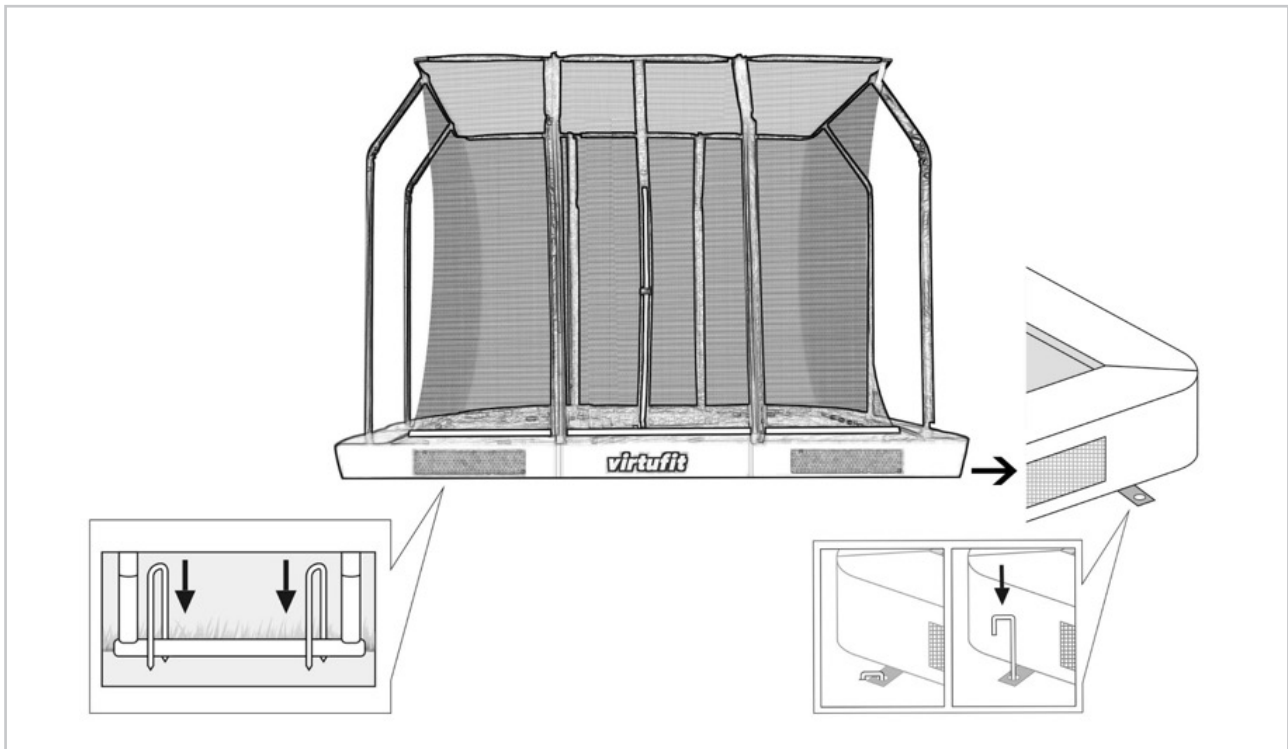

IMPORTANT WARNING

After assembled all steps, it is important that you perform the following safety checks:

- **Ensure all screws and bolts are tightly secured.**
- **Check all springs are hooked securely to the frame and jumping mat rings.**
- **Inspect the spring cover and check it is covering the springs and frame and that it is tied securely.**

INSTRUCTIONS

- Moving trampoline. If the trampoline and enclosure needs to be moved, it should be moved by two persons at least, kept horizontal, and lifted slightly.
- If necessary, the trampoline and enclosure can be taken for moving. To take the trampoline apart, follow the assembly steps in reverse order.
- If you need to move the trampoline, two people should be used at least.
- All connector points should be wrapped secured with weather resistant tape, such as duct tape. This will keep the frame intact during the move and prevent the connector points from dislocating and separating.
- When moving, lift the trampoline slightly of the ground and keep it horizontal to the ground. For any type of other move, you should disassemble the trampoline.

DAILY MAINTENANCE

- Clean and remove sweat / moisture after each use. Do not use aggressive cleaning agents
- Check that the trampoline is free from dust and dirt.

SEMI-ANNUAL MAINTENANCE

- Inspect all bolts and nuts related to the trampoline, tighten as required.

BASIC SKILLS USING THE TRAMPOLINE

BASE JUMP

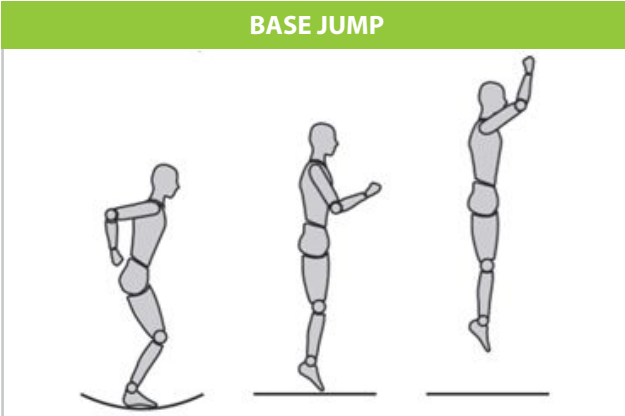

1. Start from a standing position with your head upright and your eyes on the frame.
2. Swing your arms forward and raise in one circular motion.
3. Bring your feet together and point your toes down while in the air.
4. Keep your feet about 1 foot apart if you lands on the bed.

KNEE JUMP

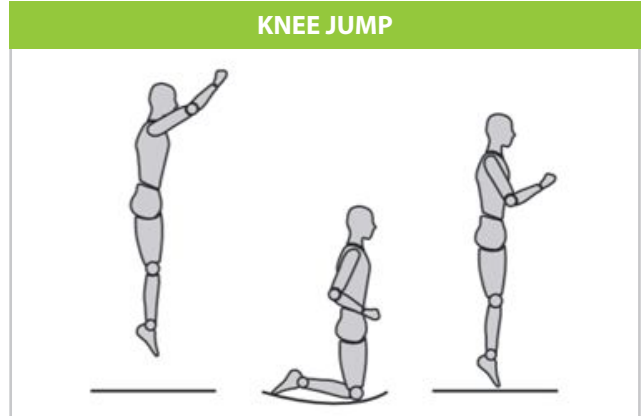

1. Start jumping from a standing position, keeping your eyes on the frame.
2. Land on your knees, keep your back straight and your body upright.
3. Bounce back to an upright position.

BELLY JUMP

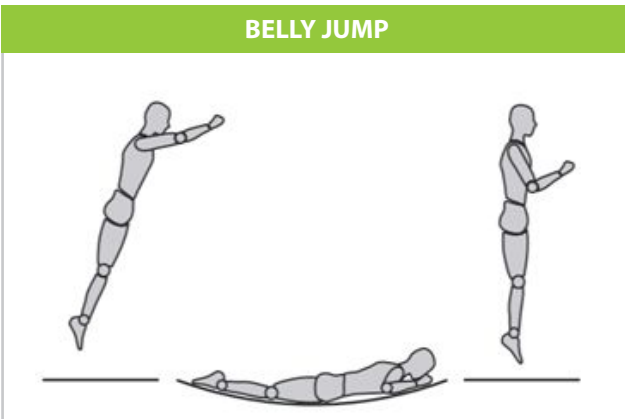

1. Start from a low jump and land on the jumping mat in a prone position.
2. Keep your head up and extend your arms on the front of the bed.
3. Push with your arms to return to one upright position.

SIT JUMP

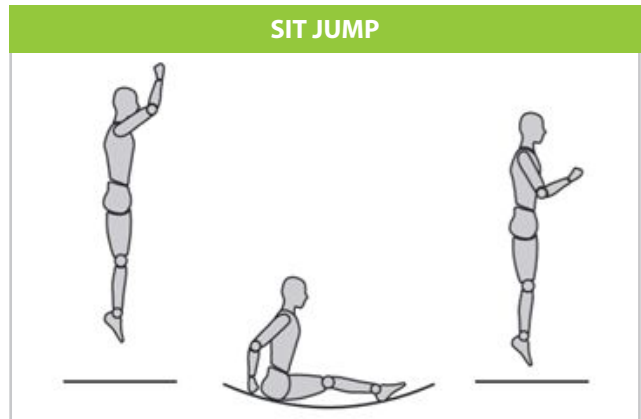

1. Land in a sitting position with your legs parallel to the jumping mat.
2. Place your hands on the jumping mat next to your Hips.
3. Push with your hands to return to one upright position.

A certified trampoline instructor should be contacted to further develop your trampoline skills

virtu profit

For questions or missing parts please contact your dealer.