

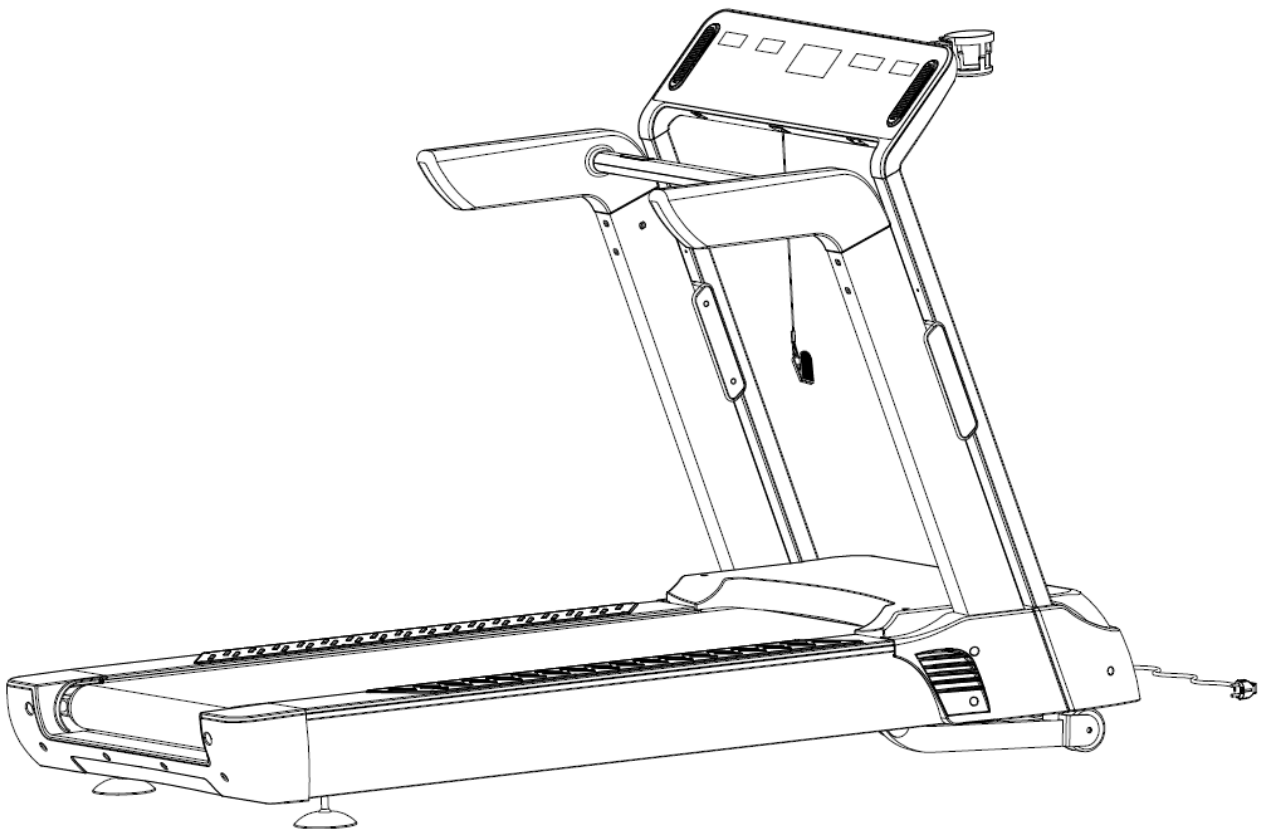

***D.C. ATHLETICS***®

# Trail Blazer I

## MANUAL





PLEASE READ THE INSTRUCTIONS CAREFULLY BEFORE  
ASSEMBLY AND USING THE TREADMILL  
KEEP THE MANUAL FOR FUTURE REFERENCE.

## WARNING

- When using this treadmill, keep attaching the safety key rope to your clothes.
- When you are running, keep your hands swinging naturally, your eyes staring forward and never look down at your feet.
- Increase the speed step by step when running.
- When emergency happens, take away the “safety key” immediately.
- Leave the treadmill after the running belt is fully stopped.

**Caution: Read the assembly instruction carefully, follow the instruction when assemble.**

## ATTENTION

- 01- Before starting any exercise program, consult with your physician or health professional.
- 02- Check all the bolts are securely locked.
- 03- Never put the treadmill in a humid area, or it will cause troubles.
- 04- We take no responsibility for any troubles or hurts due to above reasons.
- 05- Dress sport clothes and shoes before running.
- 06- Do not do exercise in 40 minutes after meal.
- 07- To prevent hurts, please warm up before exercise.
- 08- Consult with doctor before exercise if you have high blood pressure.
- 09- The treadmill is only used for adults.
- 10- Do not plug anything into any parts of this equipment, or it may be damaged.
- 11- Do not connect line to the middle of cable; do not lengthen cable or change the cable plug; do not put anything heavy on cable or put the cable near heat source; forbid using socket with several holes, these may cause fire or people may be hurt by the power.
- 12- Switch off the power when the equipment is not used. When the power is cut off, do not pull the power line to keep the wire unbroken.

14. Maximum weight of user 170KGS.

15. Pulse data may not be very accurate, so can not be used for medical purpose. Over-exercise may cause injury, even death. If you have a feeling of dizziness, sickness or other abnormal symptoms, please stop training and consult a doctor immediately.

## **IMPORTANT SAFETY PRECAUTIONS**

1. Plug the power cord of the treadmill directly into a dedicated grounded circuit. This product must be grounded. If it has breakdown, grounding provides a path of least resistance for electric current to reduce the risk of electric shock.

2. Position the treadmill on a clear, level surface. Do not place the treadmill on thick carpet as it may interfere with proper ventilation. Do not place the treadmill near water or outdoors.

3. Position treadmill so that the wall plug is visible and accessible.

4. Never start the treadmill while you are standing on the walking belt. After turning the power on and adjusting the speed control, there may be a pause before the walking belt begins to move, always stand on the foot rails on the sides of the frame until the belt is moving.

5. Wear appropriate clothing when exercising on the treadmill. Do not wear long, loose fitting clothing that may be caught in the treadmill. Always wear running or aerobic shoes with rubber soles.

6. Make sure the power supply is connected and the safety key is effective before using the treadmill. Fit one side of the safety key on the treadmill and clip the other side on your clothes or belt, which will enable you to pull off the safety lock promptly in an emergency.

7. Always unplug the power cord before removing the treadmill motor cover.

8. Make sure there is no less than 2\*1m space behind the treadmill.

9. Keep children away from the treadmill during operation.

10. Always hold the handrails when initially walking or running on the treadmill, until you are comfortable with the use of the treadmill.

10. Always attach the safety key rope to your clothing when using the treadmill. If the treadmill should suddenly increase in speed due to an electronics failure or the speed being inadvertently increased, the treadmill will come to a sudden stop when the safety key is disengaged from the console.

12. In case of any abnormality during the use process, please remove the safety key immediately, grasping the handlebar and jumping onto the two edgings, then get off the treadmill after it stops.

13. When the treadmill is not being used, the power cord should be unplugged and the safety key removed.

14. Put the safety key away where it can not be reached by the children.

15. Before starting any exercise program, consult with your physician or health professional. He or she can help establish the exercise frequency, intensity (target heart zone) and time appropriate for your particular age and condition. If you have any pain or tightness in your chest, an irregular heartbeat, shortness of breath, feel faint or have any discomfort while you exercise, STOP! Consult your physician before continuing.

16. If you observe any damage or wear on the mains plug or on any section of the mains lead then please have them replaced immediately by a qualified electrician – do not attempt to change or repair these yourself.

17. If the supply cord is damaged, it must be replaced by the manufacturer, its service agent or similarly qualified persons in order to avoid a hazard.

18. Put your feet on the side rail before using the treadmill, and always attach the safety key rope to your clothing. Hold the handle bar before the running belt moving well (feel the running speed by your single foot before using it). To avoid losing balance, please slow down the speed to the lowest or take off the safety lock. And hold the handle bar to jump to the side rails when emergency or the safety key is not attached.

## ASSEMBLY STEPS

### *STEP 1:*

Open the package, take out all parts and place the main frame on the flat ground.

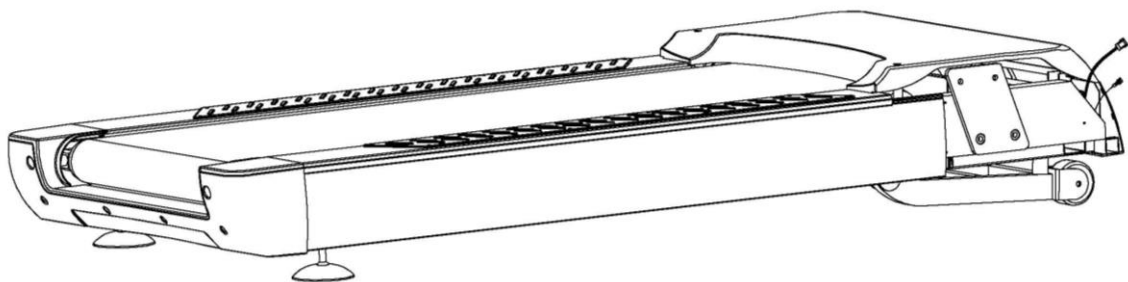

### *STEP 2*

1. Disassemble Cross slotted washer screw (56) and Cross slotted washer screw (57), and take out the motor cover (18) from the main frame (1).

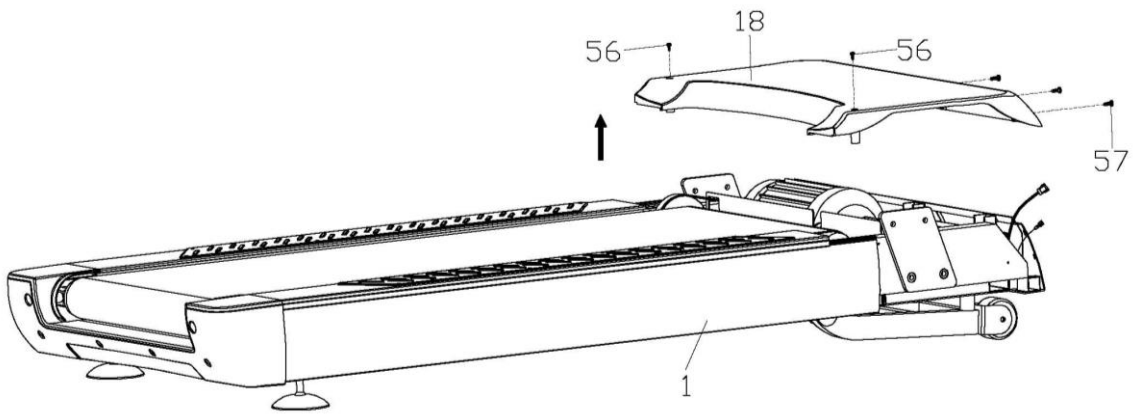

**STEP 3:**

1. Link the left end cover backlight power lower wire (71) with left end cover backlight power upper wire (72),
2. Link the right end cover backlight power lower wire (73) with right end cover backlight power upper wire (74),
3. Link the computer lower wire (81) with connecting wire (82).
4. Lock the upright tube (2L/R) to the main frame (1) with hex bolt (53) and locked washer (69). (Note: Please don't lock the hex bolt (53) tightly now.)

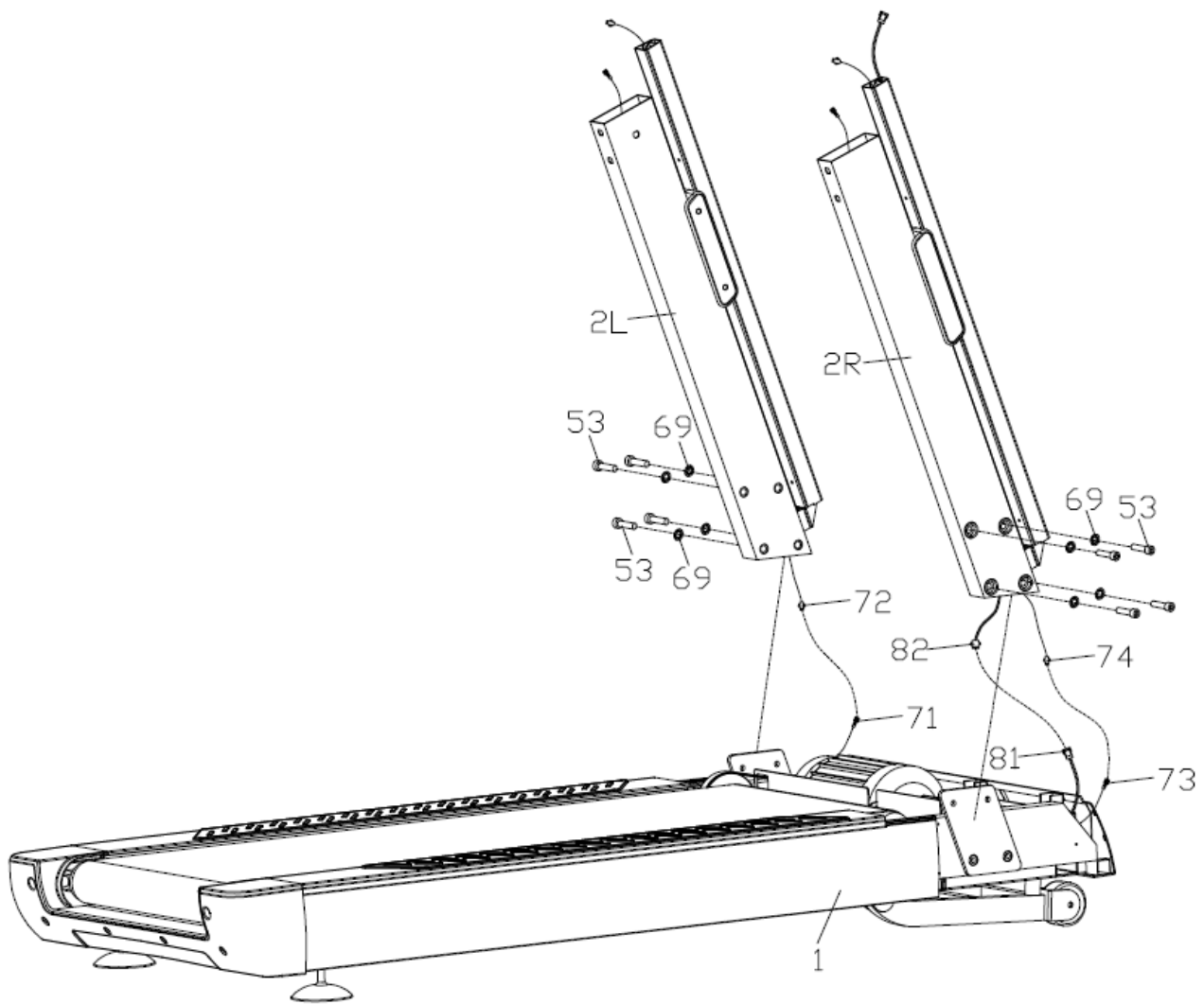

**STEP 4:**

1. Link the connecting wire A on the front armrest (6) to the B point of the heart rate lower wire (78)
2. Insert the armrest (8L/R) to the front armrest (6) separately, match the holes, then lock them tightly with hex bolt (58) and locked washer (70).
3. Link the heart rate lower wire (78) and heart rate connecting wire (79); Lock the armrest (8L/R) to the upright tube (2L/R) with hex bolt (49) and locked washer (65). (Note: Please don't lock the hex bolt (49) tightly now.)

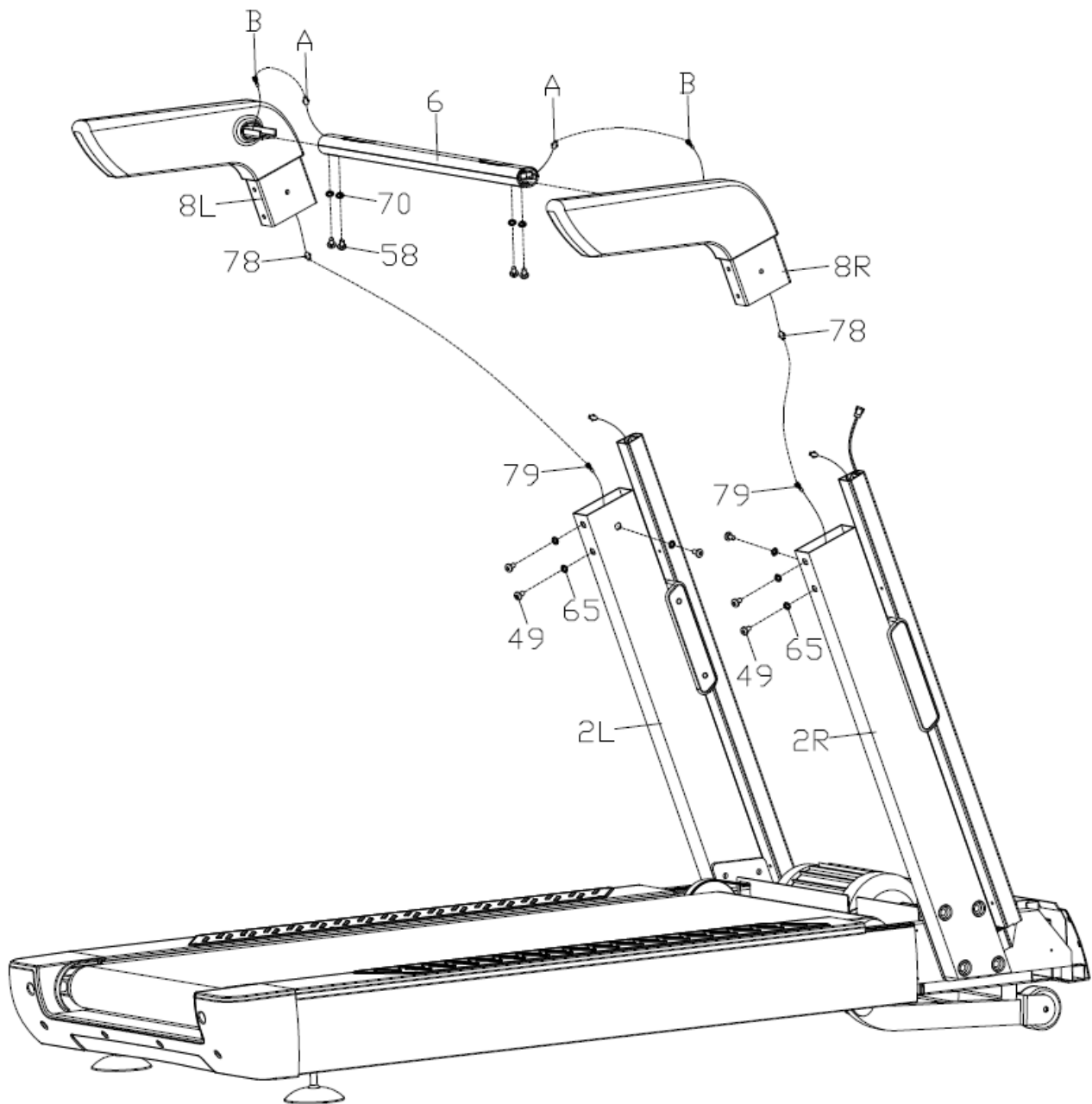

**STEP 5:**

1. Please connect below wires as Image 1 shown:  
 Connect heart rate connecting wire (79) with heart rate upper wire (80);  
 Connect computer connecting wire (82) with computer upper wire (83).
2. Lock the computer frame (7) to the rear upright tube (4L/R) with hex bolt (58) and locked washer (70), then cover the rear upright tube plug (28).
3. Lock all screws tightly now.
4. Insert the water bottle holder (94) in the iron G on the computer frame(7).

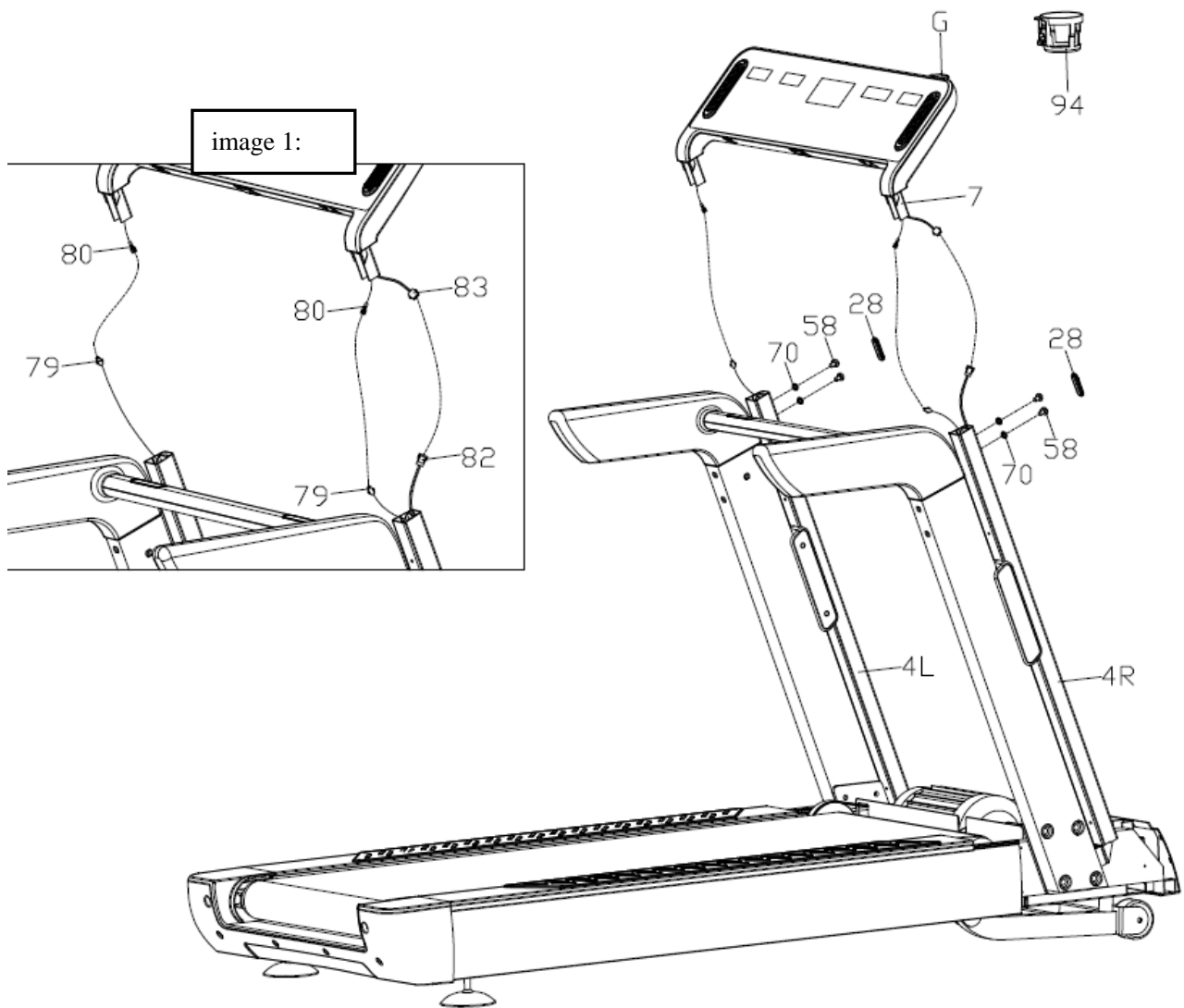

**STEP 6:**

1. Tighten the Motor side cover (22L/R) to the main frame (1) with cross slotted washer screw (57) ;
2. Put the motor cover (18) to the main frame (1), match the holes, then lock the motor cover (18) to the main frame (1) with cross slotted washer screw (56) and cross slotted washer screw (57).
3. Insert the plug 1 (42) to the holes of motor cover (18).



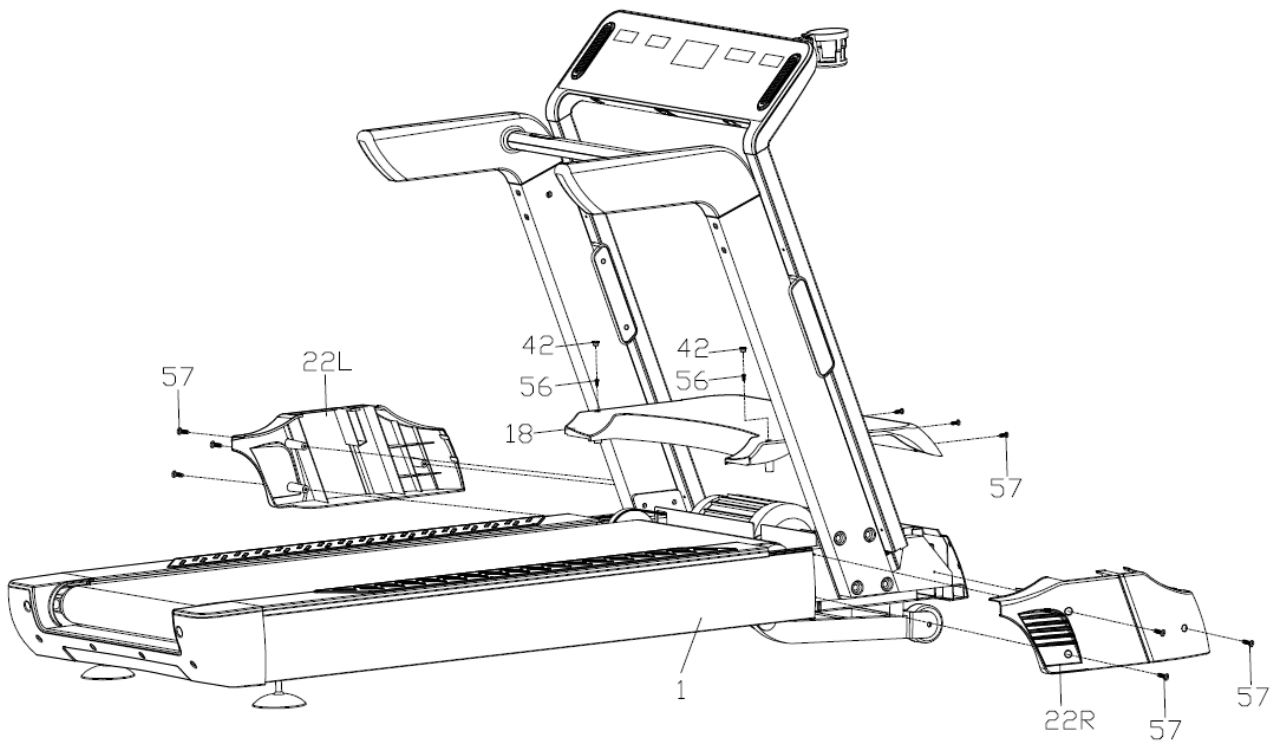

**STEP 7:**

Insert the end of power cord (86) to the power plug of the main frame (1).

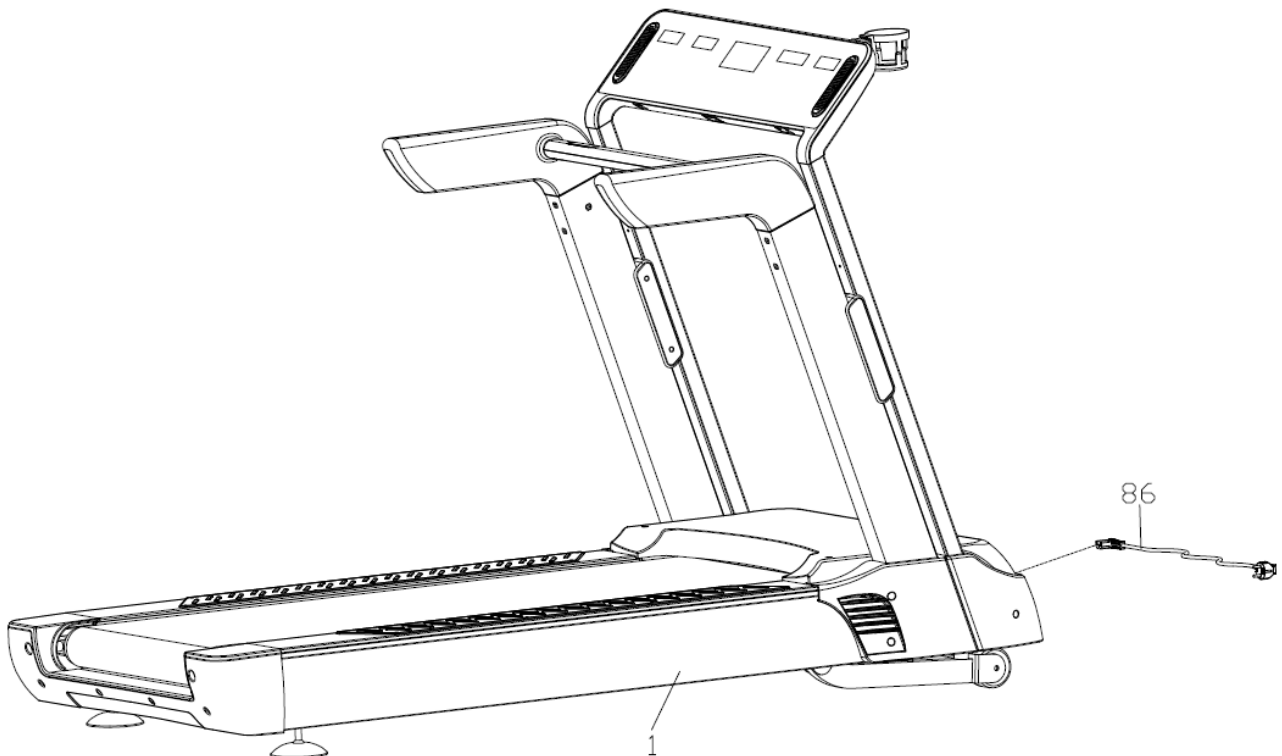

The method of using the Shelf:

Part	Description	Qty
------	-------------	-----

Image 1

Image 4



图4

No.		
A	Board	1
B	Extended frame	1
C	Supported frame	1
D	PAD/Phone	1

### Step one:

Hold the boss of the board A, pull the extended frame B and supported frame C out from the computer. (the position of the boss is showed as picture 4)

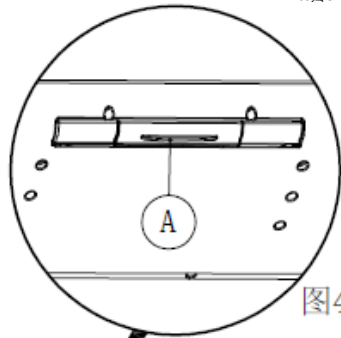

图1

Image 2

### Step two:

Rotate the board A as the direction of the arrow in the picture 2, then push it to the left.

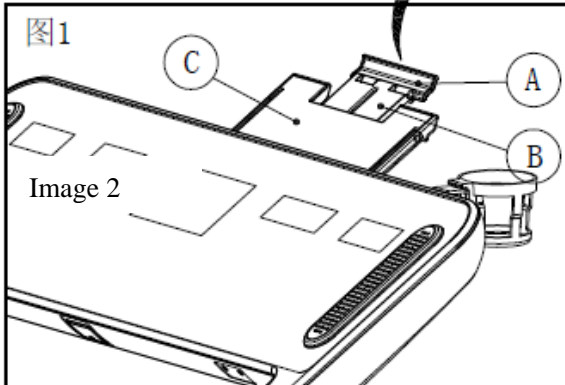

图2

Image 3

### Step three:

Put the PAD/Phone on the extended frame B and supported frame C, clamp it with board A.

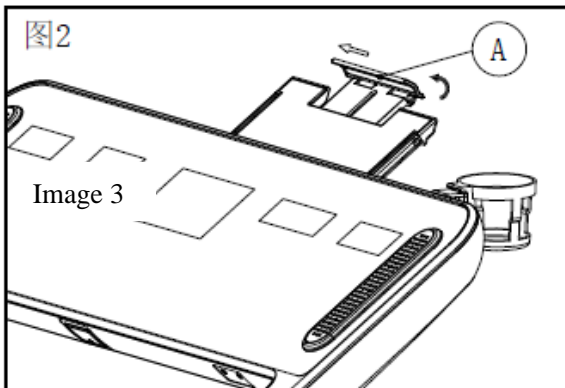

图3

### The method of putting away

### the Shelf:

Part No.	Description	Qty
A	Board	1
B	Extended frame	1

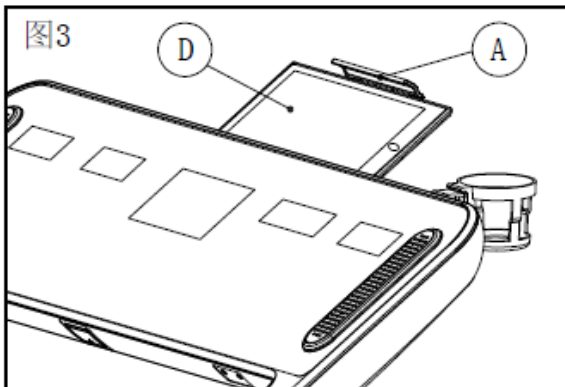
C	Supported frame	1
D	PAD/Phone	1

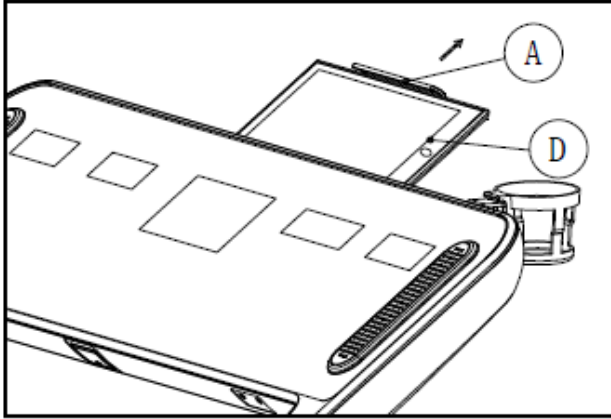

### Step one:

Pull out the board A as the direction of the arrow in the picture, take away the PAD/Phone.

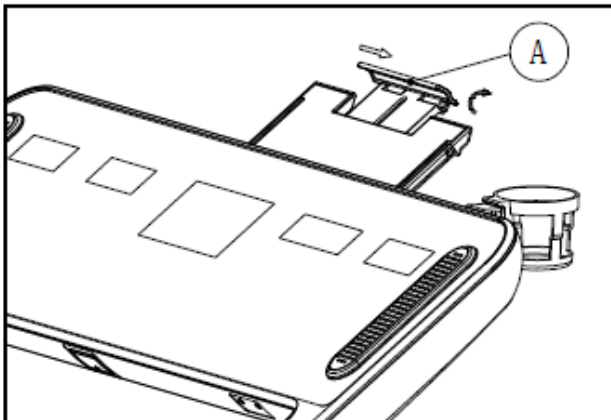

### Step two:

Push the board A to the right, then rotate it as the direction of the arrow in the picture.

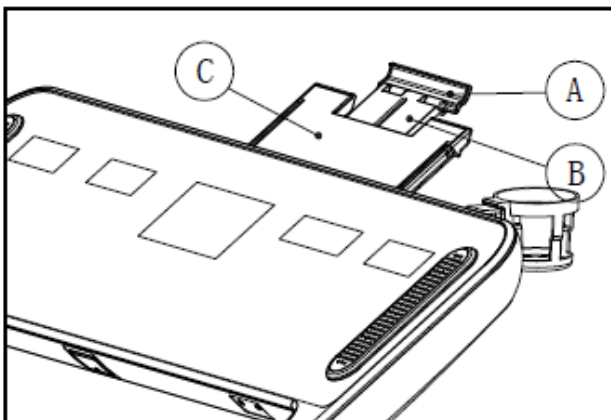

### Step three:

Hold the board A, let the extended frame B and supported frame C turn back in the computer.

## GROUNDING METHODS

This product must be grounded. If it should malfunction or breakdown, grounding provides a path of least resistance for electric current to reduce the risk of electric shock.

This product is equipped with a cord having an equipment-grounding conductor and a grounding plug. The plug must be plugged into an appropriate outlet that is properly installed and grounded in accordance with all local codes and ordinances.

**DANGER** – Improper connection of the equipment-grounding conductor can result in a risk of electric shock. Check with a qualified electrician or serviceman if you are in doubt as to whether the product is properly grounded.

Do not modify the plug provided with the product – if it will not fit the outlet, have a proper outlet installed by a qualified electrician.

This product is for use on a nominal **220-volt** circuit and has a grounding plug that is accordance with VDE. Make that the product is connected to an outlet having the same configuration as the plug. No adaptor should be used with this product.

Please pay great attention to the voltage of power and the plug of the power. Wrong voltage and plug will cause fault of the product. Below plug just for setting reference.

### Grounding Methods

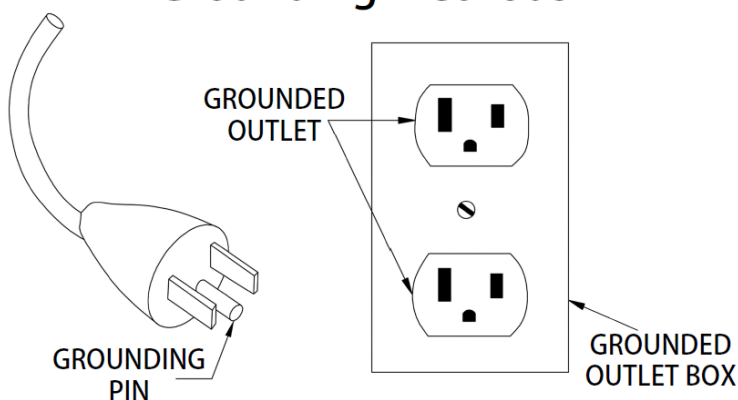

### TECHNICAL PARAMETER

<b>ASSEMBLY SIZE (mm)</b>	2090x890x1400	<b>POWER</b>	AS ORDER
<b>RUNNING SURFACE (mm)</b>	550x1550	<b>MAX OUTPUT POWER</b>	AS ORDER
<b>NET WEIGHT</b>	169KG	<b>INPUTVOLTAGE</b>	220V
<b>GROSS WEIGHT</b>	191.5KG	<b>SPEED RANGE</b>	1.0-22 KM/H
<b>MAX USER'S WEIGHT</b>	170KG	<b>INCLINE</b>	0-15 level

### OPERATION INSTRUCTIONS

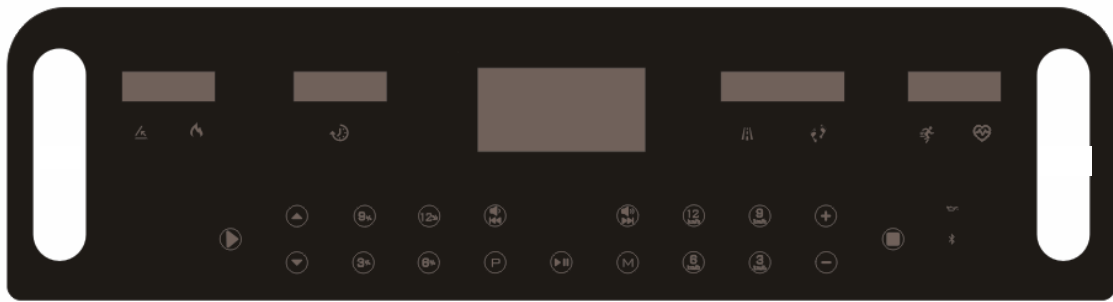

## 1. Window display

### 1.1. : display incline and calories in turn

: display incline

: display calories

### 1.2. : display time

### 1.3. : display distance and steps in turn

: display distance

: display steps

### 1.4. : display speed and heart rate in turn

: display speed

: display heart rate

### 1.5. Middle dot matrix: display the runway and the number of turns, 400 meet per turn.

### 1.6. : display bluetooth (optional)

### 1.7. : display refueling

## 2. Button function

Press for 3s with normal start.

### 2.1. Program key:

18 Preset programs, 3 USER setting programs, Body fat Test programs.

### 2.2. Mode key

Press this button to loop the selection "0:00", "30:00", "1.0", "50:0" ("0:00" is manual mode, "30:00" is time countdown mode, "1.0" is distance countdown mode, "50:00" is calorie counting mode.) When choosing various modes, the speed and slope can be

used to set the correlation, you can press  to start the treadmill after finishing setting.

### 2.3. Start key

“START” for startup, press SRATR the treadmill will run at minimal speed

### 2.4. Stop key

“STOP” for stop, the treadmill will stop when the key pressed.

### 2.5. 、 Speed +/-

Extra key for speed: standby status to adjust the set value. After starting, the adjustment speed is adjusted, and the adjustment range is 0.1km/time, and it will continue to increase or decrease automatically when it lasts for more than 0.5 seconds.

### 2.6. 、 INCLINE+/-

“INCLINE+” and “INCLINE-” are for slop adjusting, which can be used for the data setting; when the treadmill is in use, the key can be used to adjust the slop, advance 1level per press; continuously press over 0.5s, it will continuously incline or decline.

### 2.7. 、、、 SPEED shortcut

3km/h, 6km/h, 9km/h, 12km/h can be set under operation condition.



### 2.8. 、、、 INCLINE SHORTCUT

3%, 6%, 9% & 12% can be set under operation condition



### 2.9. Kilometer transform with mile

Take off the safety key, press PROGRAM and MODE for three seconds at the same time.

### 2.10. USB play control key

 Play/pause,  Volume reduction (long press)/previous song(short press),  Volume + (long press)/next song(short press)





### 2.11. Refueling reminder function

The buzzer rings five times, the fill cue icon  will light up per 300KM. Ready mode, long press  stop key, you can cancel the reminder.





## 3.Quick start( manual mode)

3.1. Turn on the power switch, attach the safety key to the safe lock position below the panel.





























3.2. Press  start key, the system enters a 3-second countdown, the buzzer sounds, the speed window shows the countdown, and the treadmill starts running at 1km/h after the countdown of 3 seconds.

3.3. The speed of the running machine can be adjusted, with  to add the speed,  to decrease the speed. Using  to increase and  to decrease the incline of the treadmill.











## 4. Operations during the exercise:

- 4.1. Press  key to reduce the speed of the treadmill.
- 4.2. Press  key to increase the speed of the treadmill.
- 4.3. Press  key to reduce the incline of the treadmill.
- 4.4. Press  key to increase the incline of the treadmill.
- 4.5. Press  key to stop the treadmill.
- 4.6. When the exerciser holds the heart rate with both hands about 3 seconds, the heartbeat data will be displayed.

## 5. Manual mode:

- 5.1. In the standby mode, press  key, the treadmill runs at a speed of 1.0km/h and a incline of 0; other Windows start positive counting from 0, press , , ,  to change the incline and speed.
- 5.2. In the standby mode, press  key to enter time countdown mode,  will show "30:00" and flicker, press , , ,  to set up time(5:00-99:00).
- 5.3. In the time countdown mode, press  to Enter distance countdown mode,  will show "1.00" and flicker, press , , ,  to set up distance(0.50-99.9).
- 5.4. In the distance countdown mode, press  to enter calorie counting mode,  will show "50.0" and flicker, press , , ,  to set up calories(10.0-999.0).
- 5.5. After setting one of the three types of countdown mode, press  key, the treadmill runs after 3 seconds, press , , ,  to adjust speed and incline; press  key, the treadmill will stop.

## 6. Preset program:

There are 18 preset programs in this system,P01-P18. In the standby mode, press  key, the window will show "P01-P18".After choosing the program,  will flicker; display preset time 30:00,press , , ,  to set up time, then press  to start the built-in programs. The built-in program has 20 segments, the time of each segment equals to setting time/20. When enter to next segment, the system will have "bi-bi-bi -" 3 sound cues, the speed and incline will change according to the program segment. Meantime, you can press , , ,  to change the speed and incline, but when enters the next program, it will return to its speed and incline. After running a program, the system will have "bi-bi-bi -" 3 sound cues, the treadmill stops running smoothly and shows "End" and enter standby mode for 5 seconds after total stop.

## 7. Program instructions:

Each program is divided into 20 sections; the operation time will be evenly distributed to each program section. Here below is an 18section program running diagram.

No.		Setup time /20 = Each segment of the running time																			
		1	2	3	4	5	6	7	8	9	10	11	12	13	14	15	16	17	18	19	20
P01	SPEED	2	3	3	4	5	3	4	5	5	3	4	5	4	4	4	2	3	3	5	3
	INCLINE	1	1	2	2	2	3	3	3	2	2	1	2	2	1	1	3	3	2	2	2
P02	SPEED	2	4	4	5	6	4	6	6	6	4	5	6	4	4	4	2	2	5	4	2
	INCLINE	1	2	2	2	2	3	3	2	2	2	2	2	3	3	3	4	4	3	2	2
P03	SPEED	1	3	3	5	5	3	6	6	6	3	6	6	3	3	3	1	3	4	2	1
	INCLINE	1	2	2	1	1	2	2	2	1	1	1	1	3	3	3	5	5	2	1	1
P04	SPEED	3	5	5	6	7	7	5	7	7	8	8	5	9	5	5	6	6	4	4	3
	INCLINE	2	3	3	2	2	3	3	3	2	2	2	2	4	4	4	6	6	3	2	2
P05	SPEED	2	4	4	5	6	7	7	5	6	7	8	8	5	4	3	3	6	5	4	2
	INCLINE	3	3	3	4	4	5	5	5	4	4	4	4	5	5	3	3	3	2	2	2
P06	SPEED	2	4	4	4	5	6	8	8	6	7	8	8	6	4	4	2	5	4	3	2
	INCLINE	3	5	5	5	4	4	4	3	3	3	3	4	4	4	3	3	3	4	3	2
P07	SPEED	2	3	3	3	4	5	3	4	5	3	4	5	3	3	3	6	6	5	3	3
	INCLINE	4	4	4	4	3	3	6	6	6	7	7	8	8	9	9	6	6	5	4	4
P08	SPEED	2	3	3	6	7	7	4	6	7	4	6	7	4	4	4	2	3	4	4	2
	INCLINE	4	5	5	5	6	6	6	7	8	9	9	9	10	10	10	12	12	8	6	3
P09	SPEED	2	4	4	7	7	4	7	8	4	8	9	9	4	4	4	5	6	3	3	2
	INCLINE	5	5	5	6	6	6	4	4	6	6	5	5	8	8	9	9	9	7	4	2
P10	SPEED	2	4	5	6	7	5	4	6	8	8	6	6	5	4	4	2	4	4	3	3
	INCLINE	5	6	6	6	7	5	8	8	4	4	4	5	5	8	8	10	10	8	6	3
P11	SPEED	2	5	8	10	7	7	10	10	7	7	10	10	5	5	9	9	5	5	4	3
	INCLINE	4	5	3	2	6	6	2	2	2	2	2	4	5	6	3	2	5	5	2	0
P12	SPEED	3	4	9	9	5	9	5	8	5	9	7	5	5	7	9	9	5	7	6	3
	INCLINE	1	2	3	2	3	5	5	0	0	2	3	5	7	3	3	5	6	5	3	3
P13	SPEED	3	3	4	4	5	5	6	6	7	7	8	8	9	6	5	5	4	4	3	3
	INCLINE	1	1	3	3	5	5	7	7	9	9	11	11	9	3	5	5	3	3	1	1
P14	SPEED	3	4	5	6	7	6	5	4	7	9	9	7	6	9	8	7	6	5	4	3
	INCLINE	0	3	3	5	5	7	7	9	9	7	7	5	5	7	7	5	5	3	3	0
P15	SPEED	9	9	9	8	8	8	7	7	7	6	6	6	5	7	8	8	8	9	9	9
	INCLINE	0	1	2	1	2	3	3	2	1	2	2	2	0	2	3	2	3	3	2	0
P16	SPEED	8	8	9	9	10	10	12	12	12	12	12	12	11	12	10	10	9	9	8	8
	INCLINE	0	0	0	0	1	1	0	0	0	1	1	0	0	0	1	1	0	0	0	0
P17	SPEED	1	2	3	4	5	6	7	8	9	10	11	12	11	2	3	4	5	6	5	4
	INCLINE	0	0	0	0	3	3	0	0	0	3	3	0	0	0	3	3	0	0	0	0
P18	SPEED	6	6	6	4	4	4	8	8	8	10	10	10	8	6	8	8	8	6	6	6
	INCLINE	0	1	1	2	2	2	0	0	0	1	1	1	0	0	1	1	1	0	0	0



## 8. User programs:

In addition to 18 built-in programs, the treadmill also has 3 customized programs to support the customized setting based on the user's specific situation: U01, U02 and U03.

### 8.1. Settings of user programs:

In the standby mode, press **P** key in succession to the user programs(U01-U03), and press **M** key to set, then you can set up the first time period, press **+**、**-** key or speed shortcut key to set the speed, press **▲**、**▼** key to set the incline, press **M** key to complete the setting of the first time period and enter the first two time periods to set the status until all 20 time periods are completed; the data will be saved until the next time you reset the data, and this data will not be lost due to power failure.

### 8.2. Startup of user programs:

- A. In the standby mode, press **P** key in succession to the user programs(U01-U03), after finish setting the time, you can press **▶** key to start,
- B. After the use program and runtime setting are completed, press **▶** key to start the treadmill.

### 8.3. Setup instructions of user programs:

Each program divides the running time into 20 periods, you need to set the speed, Incline and running time of all 20 periods then press **▶** key to start the treadmill.

## 9. Body fat test:

In the standby state, press **P** key continuously to enter body fat test program. The window display "FAT". Press **M** key to select the parameter of F1(gender), F2(age), F3(height), F4(weight), F5(body fat test). Press **▲**、**▼**、**+**、**-** to set the parameter of 01-04(see below detailed table), the window display F5 after setting. At this state, hold the handle pulse board for 5-6 seconds and it will display the FAT, check if the weight matches with your height. FAT is to measure the relevance between height and weight, not the body proportion. FAT is suitable for every man and woman, it provide the important grounds for adjusting the weight with other health indicators. The perfect FAT is between 20-24, which means if less than 19 is too thin, and if between 25-29 is overweight and if more than 30 is obesity. (The parameter is only for reference, not medical judgment)

<b>F--1</b>	<b>Gender</b>	<b>01(man)</b>	<b>02(woman)</b>
<b>F--2</b>	<b>Age</b>	<b>10-----99</b>	
<b>F--3</b>	<b>Height</b>	<b>100-----200</b>	
<b>F--4</b>	<b>Weight</b>	<b>20-----150</b>	
<b>F--5</b>	<b>FAT</b>	<b>≦ 19</b>	<b>Under weight</b>
	<b>FAT</b>	<b>=(20--24)</b>	<b>Normal weight</b>
	<b>FAT</b>	<b>=(25--29)</b>	<b>Over weight</b>
	<b>FAT</b>	<b>≧ 30</b>	<b>Obesity</b>

## 10. Range of values:

Set parameter	Initial value	Set initial value	Setting range	Display range
Time(minute:second)	0:00	30:00	5:00-99:00	0:00—99:59
Incline (level)	0	N/A	N/A	0-15
Speed (KM/H)	0.0	N/A	N/A	1.0-22.0KMH 0.6-13.6MPH
Distance(KM)	0.00	1.00	0.50-99.9	0.00—99.9
Heart rate(Times/min)	P	N/A	N/A	50-200
Calories(Kilocalorie)	0.0	50.0	10.0-999.0	0.0—999.0

## 11. Functions of the safety key:

In any state, pulling off the safety key can stop the treadmill urgently, when the treadmill stops urgently, the window displays "---", and the buzzer sends a "BB" alarm 3 times; at this time, the treadmill can't perform any other operation except shutdown. After the safety key is properly installed, the treadmill is reentered into standby mode, waiting to be input instructions.

## 12. Power saving mode:

This system has the power saving function, in the standby state, if there is no key instruction input in 10 minutes, the system will enter the power saving mode and shutdown the display automatically, and the system can be reawakened by pressing any key.

## 13. MP3/SD/USB/Music Bluetooth function (Optional):

This computer can play music when the power is connected to an MP3 or other audio device. The sound volume control is on the audio device. Please control the volume of the sound to avoid the quality of the sound and the built-in audio circuit.

The function of music bluetooth: when the treadmill is power on, turn on the bluetooth on the phone, and connect to the music bluetooth on the treadmill, then the treadmill can play songs on the phone

## 14. HRC Pattern:

Press the program button in standby mode, select HP1-HP3, Press mode button to enter the age or target heart settings, the adjusting range can be seen in the table blow

Age	HR			Age	HR			Age	HR		
	Min	Default	Max		Min	Default	Max		Min	Default	Max
15	123	123	195	37	110	110	174	59	97	97	153
16	122	122	194	38	109	109	173	60	96	96	152
17	122	122	193	39	109	109	172	61	95	95	151
18	121	121	192	40	108	108	171	62	95	95	150

19	121	121	191	41	107	107	170	63	94	94	149
20	120	120	190	42	107	107	169	64	94	94	148
21	119	119	189	43	106	106	168	65	93	93	147
22	119	119	188	44	106	106	167	66	92	92	146
23	118	118	187	45	105	105	166	67	92	92	145
24	118	118	186	46	104	104	165	68	91	91	144
25	117	117	185	47	103	103	164	69	91	91	143
26	116	116	184	48	103	103	163	70	90	90	143
27	116	116	183	49	103	103	162	71	89	90	142
28	115	115	182	50	102	102	162	72	89	90	141
29	115	115	181	51	101	101	161	73	88	90	140
30	114	114	181	52	101	101	160	74	88	90	139
31	113	113	180	53	100	100	159	75	87	90	138
32	113	113	179	54	100	100	158	76	86	90	137
33	112	112	178	55	99	99	157	77	86	90	136
34	112	112	177	56	98	98	156	78	85	90	135
35	111	111	176	57	98	98	155	79	85	90	134
36	110	110	175	58	97	97	154	80	84	90	133

1. Start at the 0 incline section, also with the lowest speed
2. The first minute is the warm up exercise and can adjust the speed and incline manually
3. After the warm up, calculate the heart rate D value (target heart rate- the user's heart rate) for the following process:
  - A. (Target heart rate- the user's heart rate) >0, when the speed increase 0.5KM/H and reach to the tip speed, the incline will increase 1 level accordingly.
  - B. (Target heart rate- the user's heart rate) <0, If the incline is not at the zero, it will decrease 1 level. Then if the incline is at the zero, the speed will decrease 0.5 KM/H and it will not decrease again after reaching to the lowest speed.
4. Repeat the operation of step 3 after the every 10 seconds
5. The top speed for HP1 , HP2 and HP3 is 8.0 、 9.0 AND 10.0KMH
6. The age adjusting range is 15-80.and the default is 30.
7. The corresponding data table between target heart rate and the age.

## 15. Power off:

Turn off the treadmill at any time by shutting down the switch so that it doesn't damage the treadmill.

## 16. Attentions:

15.1 Check whether the power supply is loaded before exercising; Check whether the safety key does work.

15.2 During the exercise, you can pull out the safety key in the abnormal situation, the treadmill will quickly slow down to stop. Then insert the safety lock, reset the device, and wait to input instructions.

15.3 If there is any problem, please contact with the dealer. For non- professional staff, please do not try to remove or repair to avoid damage to the equipment.

## 17. Meanings of error message codes:

Error code	Exception	Possible reasons	Solution
E01	Inverter communication fault	The connecting wire of computer and controller is broken	Replace the connecting wire
		The joint is loosen	Connect the joint again, make sure it is connected
E03	Over voltage	external AC over voltage	Make sure the external voltage is below 270V
		Inverter fault	Replace the inverter
E04	Over current	The transmission part is stuck	Replace the parts
		The inverter parameters do not match the motor	Replace the inverter
E05	Over loading	User's weight over the max weight	
		Running belt is short of oil	Add the lubrication
		The inverter broken	Replace the inverter
E06	MCU fault	The inverter broken	Replace the inverter
E07	The inverter over heating	The inverter fan mouth is blocked	Clean up sundries
		The inverter fan broken	Replace the inverter
E08	The inverter cannot receive signals from the display board	Communication wire broken	Replace the wire
		Computer broken	Replace the computer
		Inverter broken	Replace the inverter
E09	The inverter internal communication error 1	Inverter broken	Replace the inverter
E10	The inverter internal communication error 2	Inverter broken	Replace the inverter
E11	Received a power-on signal, but before that, never received any power-off signal.	Communication is interrupted	Restart power supply
		Program disorder	Replace the inverter
E14 E15 E16	Inverter phase loss	Check the connection of motor wire and inverter	

## 18. Calorie calculation method:

$$70.3 \times V(\text{Km/h}) \times t(\text{h}) \times (1 + ?\%)$$

When the lifting is 0, the calorie consumption for each 1km of running is about 70.3cal.

# EXERCISE INSTRUCTIONS

## 1. The Warm Up Phase

This stage helps get the blood flowing around the body and the muscles working properly. It will also reduce the risk of cramp and muscle injury. It is advisable to do a few stretching exercises as shown below. Each stretch should be held for approximately 30 seconds, do not force or jerk your muscles into a stretch - if it hurts, **STOP**.

## 2. The Exercise Phase

This is the stage where you put the effort in. After regular use, the muscles in your legs will become Stronger. Work to your but it is very important to maintain a steady tempo throughout. The rate of work should be sufficient to raise your heart beat into the target zone shown on the graph below.

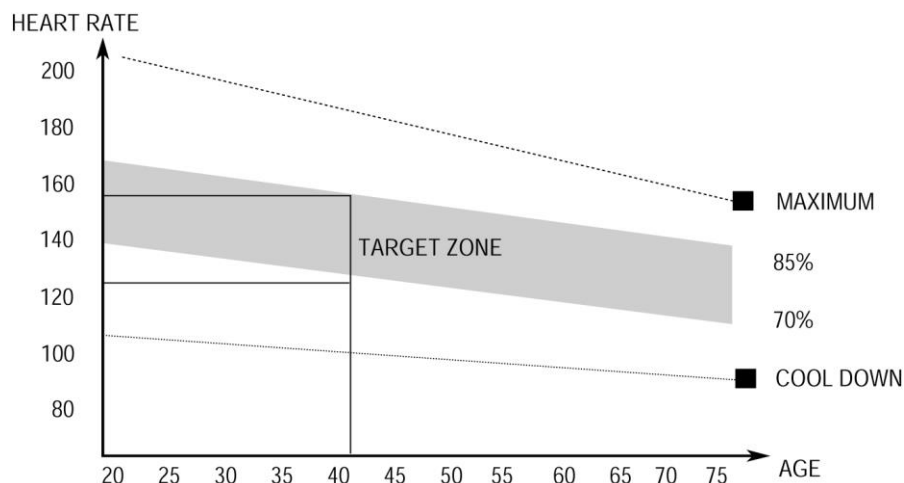

This stage should last for a minimum of 12 minutes though most people start at about 15-20 minutes

## 3. The Cool Down Phase

This stage is to let your Cardio-vascular System and muscles wind down. This is a repeat of the warm up exercise e.g. reduce your tempo, continue for approximately 5 minutes. The stretching exercises should now be repeated, again remembering not to force or jerk your muscles into the stretch.

As you get fitter you may need to train longer and harder. It is advisable to train at least three times a week, and if possible space your workouts evenly throughout the week.

To tone muscle while on your Treadmill you will need to have the resistance set quite high. This will put more strain on our leg muscles and may mean you cannot train for as long as you would like. If you are also trying to improve your fitness you need to alter your training program. You should train as normal during the warm up and cool down phases, but towards the end of the exercise phase you should increase resistance, making your legs work harder than normal. You may have to reduce your speed to keep your heart rate in the target zone.

The important factor here is the amount of effort you put in. The harder and longer you work the more calories you will burn. Effectively this is the same as if you were training to improve your fitness, the difference is the goal.

## MAINTENANCE INSTRUCTIONS

### WALKING BELT CENTERING AND TENSION ADJUSTMENT

**DO NOT OVERTIGHTEN the walking belt.** This may cause reduced motor performance and excessive roller wear.

#### TO CENTER WALKING BELT:

- Place treadmill on a level surface
- Run treadmill at approximately 3.5 mph
- If the belt offs the track to the right side, please screw the right adjusting bolt clockwise slowly, noticing the change of the deviating distance, until center the belt. (Attention: the space between the belt and the right/left edgings is at a distance normally. And the gap between the right and left distance should be no more than 5mm.
- If the belt offs the track to the left side, please screw the left adjusting bolt clockwise slowly, noticing the change of the deviating distance, until center the belt. (Attention: the space between the belt and the right/left edgings is at a distance normally. And the gap between the right and left distance should be no more than 5mm.

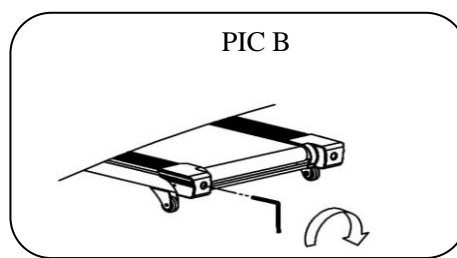
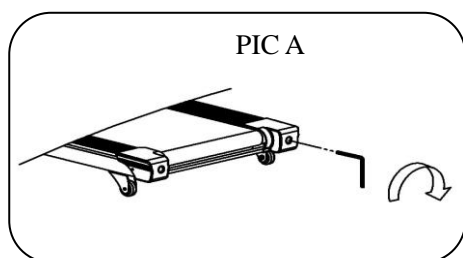

**Picture A:** If the belt has drifted to the RIGHT

**Picture B:** If the belt has drifted to the LEFT

## TENSIONING THE BELT

If you can feel a slipping sensation when running on the treadmill, the running belt must be tightened.

In most cases, the belt has stretched from use, causing the belt to slip. This is a normal and common adjustment. To eliminate this slipping, tension both the rear roller bolts with the appropriate size allen wrench, turning it **1/4 TURN** to the right as shown. Try the treadmill again to check for slipping.

Repeat if necessary, but NEVER TURN the roller bolts more than **1/4 turn** at a time. The belt tension is set properly when the running belt is **50 - 75mm** from the deck.

**WARNING: ALWAYS UNPLUG THE TREADMILL FROM THE ELECTRICAL OUTLET BEFORE CLEANING OR SERVICING THE UNIT.**

## CLEANING

General cleaning of the unit will greatly prolong the treadmill. Keep treadmill clean by dusting regularly.

Be sure to clean the exposed part of the deck on either side of the walking belt and also the side rails.

This reduces the build up of foreign material underneath the walking belt.

The top of the belt may be cleaned with a wet, soapy cloth. Be careful to keep liquid away from inside the motorized treadmill frame or from underneath the belt. **Warning: Always unplug the treadmill from the electrical outlet before removing the motor cover.** At least once a year remove the motor cover and vacuum under the motor cover.

## WALKING BELT AND DECK LUBRICATION

This treadmill is equipped with a pre-lubricated, low maintenance deck system. The belt/ deck friction may play a major role in the function and life of your treadmill, thus requiring periodic lubrication. We recommend a periodic inspection of the deck.

We recommend lubrication of the deck according to the following timetable:

- **Light user (less than 3 hours/ week)**                      **annually**
- **Medium user (3-5 hours/ week)**                              **every six months**
- **Heavy user (more than 5 hours/ week)**                      **every three months**

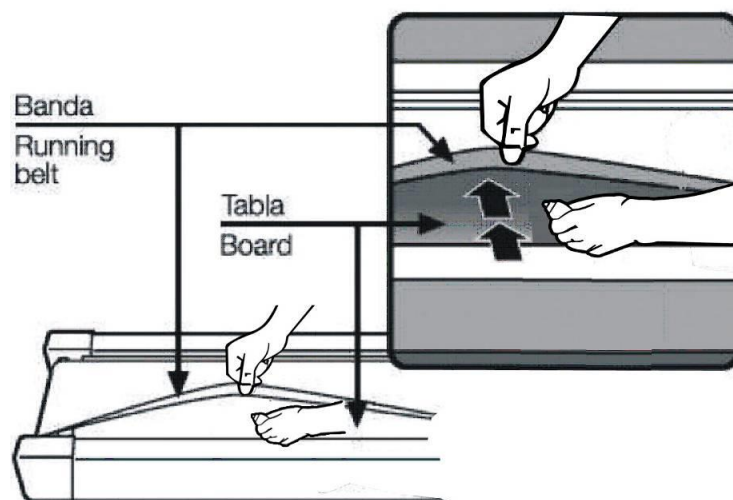



# EXPLODED DRAWING

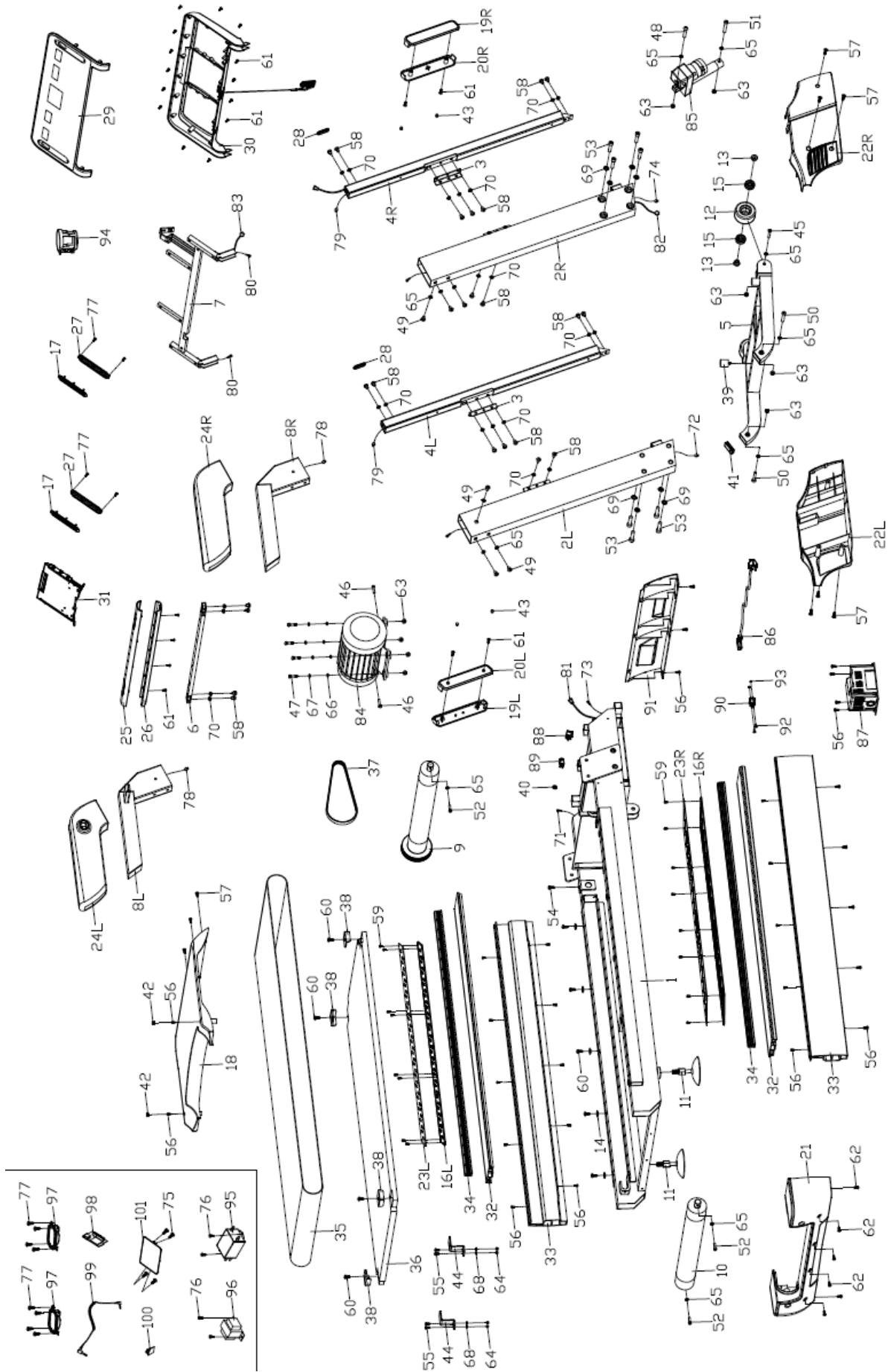

# PARTS LIST

Part No.	Description	Qty	Part No.	Description	Qty
1	Main frame	1	51	Hex bolt M10*115	1
2 L/R	Upright tube	1 p.r.	52	Hex bolt M10*75	3
3	Linking metal plate	2	53	Hex bolt M12*50	8
4 L/R	Rear upright tube	1 p.r.	54	Cross pan head screw M6*20	1
5	Incline frame	1	55	Cross pan head screw M6*15	4
6	Front armrest	1	56	Cross slotted washer screw M5*15	29
7	Computer frame	1	57	Cross slotted washer screw M4*8	9
8 L/R	Armrest	1 p.r.	58	Hex bolt M8*15	22
9	Front roller	1	59	Hex bolt M6*60	16
10	Rear roller	1	60	cross countersunk head tapping screw ST4*16	14
11	Adjustable pad	2	61	Cross pan head tapping screw ST4*16	39
12	PU Roller	2	62	Cross grooved head tapping screw ST4*12	6
13	Bearing spacer	4	63	Nylon nut M10	10
14	Edging washer	10	64	Hex nut M6	4
15	Bearing 6203-2RS	4	65	Locked washer $\Phi$ 10*1.2	21
16L/R	Metal non-slip sheet	1 p.r.	66	Flat washer $\Phi$ 10*2.0	4
17	Speaker net	2	67	Spring washer $\Phi$ 10	4
18	Motor cover	1	68	Spring washer $\Phi$ 6	4
19L/R	Upright tube cover 1	1 p.r.	69	Locked washer $\Phi$ 12	8
20L/R	Upright tube cover 2	1 p.r.	70	Locked washer $\Phi$ 8	22
21	End cap	1	71	Left upright tube backlight power lower line	1
22L/R	Motor side cover	1 p.r.	72	Left upright tube backlight power upper line	1
23L/R	Anti-skid pad	1 p.r.	73	Right upright tube backlight power lower line	1
24L/R	Foam grip	1 p.r.	74	Right upright tube backlight power upper line	1
25	Front armrest upper cover	1	75	Cross pan head tapping screw ST4*8	4
26	Front armrest bottom cover	1	76	Cross pan head screw M4*8	4
27	Speaker cover	2	77	cross countersunk head tapping screw ST4*8	12
28	Rear upright tube plug	2	78	Heart rate lower wire	2
29	Computer upper cover	1	79	Heart rate connecting wire	1
30	Computer bottom cover	1	80	Heart rate upper wire	1
31	PAD/Phone holder	1	81	Computer lower wire	1
32	Edging	2	82	Computer connecting wire	1
33	Side edging	2	83	Computer upper wire	1
34	cushion	2	84	AC motor	1
35	Running belt	1	85	Incline motor	1
36	Running board	1	86	Power cord	1
37	Belt	1	87	Inverter	1
38	Running board limit	4	88	Switch	1

39	Cushion	2	89	Overload protector	1
40	Protective plug	1	90	Power plug	1
41	Square end cap	2	91	Motor front cover	1
42	Cap 1	2	92	cross countersunk head screw M3*15	2
43	Cap 2	4	93	Hex nut M3	2
44	Pressing board	2	94	Water bottle holder	1
45	Hex bolt M10*70	2	95	Amplifier board (Optional)	1
46	Hex bolt M10*40	2	96	Filter (Optional)	1
47	Hex bolt M10*20	4	97	Inductor (Optional )	2
48	Hex bolt M10*40	1	98	Loudspeaker (Optional)	2
49	Hex bolt M10*20	6	99	USB/Bluetooth module (Optional)	1
50	Hex bolt M10*50	2	100	Audio cable	1
				MP3/Headphone interface (Optional)	1