

SOLE[™]
FITNESS

**OWNER'S MANUAL
E35 Elliptical Trainer**

*Please carefully read this entire manual
before operating your new elliptical.*

ATTENTION: *Before returning your Sole product to any retailer, or if you require any assistance with assembly or technical support please call us first for assistance at 866-697-6531. Thank you for your Sole purchase.*

TABLE OF CONTENTS

<u>Product Registration</u>	1
<u>Important Safety Instructions</u>	2
<u>Important Electrical Information</u>	3
<u>Important Operation Instructions</u>	4
<u>Transport Instructions</u>	4
<u>E35 Assembly Instructions</u>	7
<u>Elliptical Features</u>	12
<u>Operation of Your New Elliptical</u>	13
<u>Bluetooth® Connectivity</u>	16
<u>Programmable Features</u>	17
<u>Using Heart Rate Monitor</u>	23
<u>General Maintenance</u>	25
<u>Manufacturer's Limited Warranty</u>	26

ATTENTION

THIS ELLIPTICAL IS INTENDED FOR **RESIDENTIAL USE ONLY** AND IS WARRANTED FOR THE APPLICATION. ANY OTHER APPLICATION **VOIDS** THIS WARRANTY IN ITS ENTIRETY.

Before returning your Sole product to any retailer, or if you require any assistance with assembly or technical support please call us first for assistance at 866-697-6531. Thank you for your Sole purchase.

SOLE

FITNESS

CONGRATULATIONS ON YOUR NEW ELLIPTICAL AND WELCOME TO THE SOLE FAMILY!

Thank you for your purchase of this quality elliptical from **SOLE**. Your new elliptical has been manufactured by one of the leading fitness manufacturers in the world and is backed by one of the most comprehensive warranties available. **SOLE** will do all we can to make your ownership experience as pleasant as possible for many years to come.

If you have any questions about your new product contact **SOLE Fitness at 866-780-SOLE (7653)**.

If you have a technical problem with your new elliptical contact **SOLE technical service at 866-MYSOLE1 (1-866-697-6531)**.

Please take a moment at this time to record below the name of the dealer, their telephone number, and the date of purchase for easy contact in the future. We appreciate your confidence in **SOLE** and we will always remember that you are the reason that we are in business. Please complete and mail your registration card today and enjoy your new elliptical.

Yours in Health,
SOLE Fitness

Name of Dealer _____

Telephone Number of Dealer _____

Purchase Date _____

PRODUCT REGISTRATION

RECORD YOUR SERIAL NUMBER

Please record the Serial Number of this fitness product in the space provided below.

Serial Number _____

REGISTER YOUR PURCHASE

The self-addressed product registration card must be completed in full and returned to **SOLE**. You can also go to www.soleellipticals.com under the support tab to register online.



E35_20151202

IMPORTANT SAFETY INSTRUCTIONS

WARNING - Read all instructions before using this appliance.

DANGER - To reduce the risk of electric shock disconnect your SOLE elliptical from the electrical outlet prior to cleaning and/or service work.

WARNING - To reduce the risk of burns, fire, electric shock, or injury to persons, install the elliptical on a flat level surface with access to a 115-volt, 15-amp grounded outlet with only the elliptical plugged into the circuit.

DO NOT USE AN EXTENSION CORD UNLESS IT IS A 14AWG OR BETTER, WITH ONLY ONE OUTLET ON THE END: DO NOT ATTEMPT TO DISABLE THE GROUNDED PLUG BY USING IMPROPER ADAPTERS, OR IN ANY WAY MODIFY THE CORD SET.

A serious shock or fire hazard may result along with computer malfunctions. See Grounding Instructions, page 3.

- Do not operate elliptical on deeply padded, plush or shag carpet. Damage to both carpet and elliptical may result.
- Keep children under the age of 13 away from this machine. There are obvious pinch points and other caution areas that can cause harm.
- Keep hands away from all moving parts.
- Never operate the elliptical if it has a damaged cord or plug. If the elliptical is not working properly, call your dealer.
- Keep the cord away from heated surfaces.
- Do not operate where aerosol spray products are being used or where oxygen is being administered. Sparks from the motor may ignite a highly gaseous environment.
- Never drop or insert any object into any openings.
- Do not use outdoors.
- To disconnect, turn all controls to the off position and then remove the plug from the outlet.
- Do not attempt to use your elliptical for any purpose other than for the purpose it is intended.
- The hand pulse sensors are not medical devices. Various factors, including the user's movement, may affect the accuracy of heart rate readings. The pulse sensors are intended only as exercise aids in determining heart rate trends in general.
- Wear proper shoes. High heels, dress shoes, sandals or bare feet are not suitable for use on your elliptical. Quality athletic shoes are recommended to avoid leg fatigue.
- This appliance is not intended for use by persons with reduced physical, sensory or mental capabilities, or lack of experience and knowledge, unless they have been given supervision or instruction concerning use of the appliance by a person responsible for their safety.

SAVE THESE INSTRUCTIONS - THINK SAFETY!

IMPORTANT ELECTRICAL INSTRUCTIONS

WARNING!

NEVER remove any cover without first disconnecting AC power.

If voltage varies by ten percent (10%) or more, the performance of your elliptical may be affected. **Such conditions are not covered under your warranty.** If you suspect the voltage is low, contact your local power company or a licensed electrician for proper testing.

NEVER expose this elliptical to rain or moisture. This product is **NOT** designed for use outdoors, near a pool or spa, or in any other high humidity environment. The operating temperature specification is 40 to 120 degrees Fahrenheit, and humidity is 95% non-condensing (no water drops forming on surfaces).

GROUNDING INSTRUCTIONS

This product must be grounded. If the elliptical should malfunction or breakdown, grounding provides a path of least resistance for electric current, reducing the risk of electric shock. This product is equipped with a cord having an equipment-grounding plug. The plug must be plugged into an appropriate outlet that is properly installed and grounded in accordance with all local codes and ordinances.

DANGER - Improper connection of the equipment-grounding conductor can result in a risk of electric shock. Check with a qualified electrician or serviceman if you are in doubt as to whether the product is properly grounded. Do not modify the plug provided with the product if it will not fit the outlet; have a proper outlet installed by a qualified electrician.

This product is for use on a nominal 110-volt circuit, and has a grounding plug that looks like the plug illustrated below. A temporary adapter that looks like the adapter illustrated below may be used to connect this plug to a 2-pole receptacle as shown below if a properly grounded outlet is not available. The temporary adapter should be used only until a properly grounded outlet, (shown below) can be installed by a qualified electrician. The green colored rigid ear-lug, or the like, extending from the adapter, must be connected to a permanent ground such as a properly grounded outlet box cover. Whenever the adapter is used, it must be held in place by a metal screw.

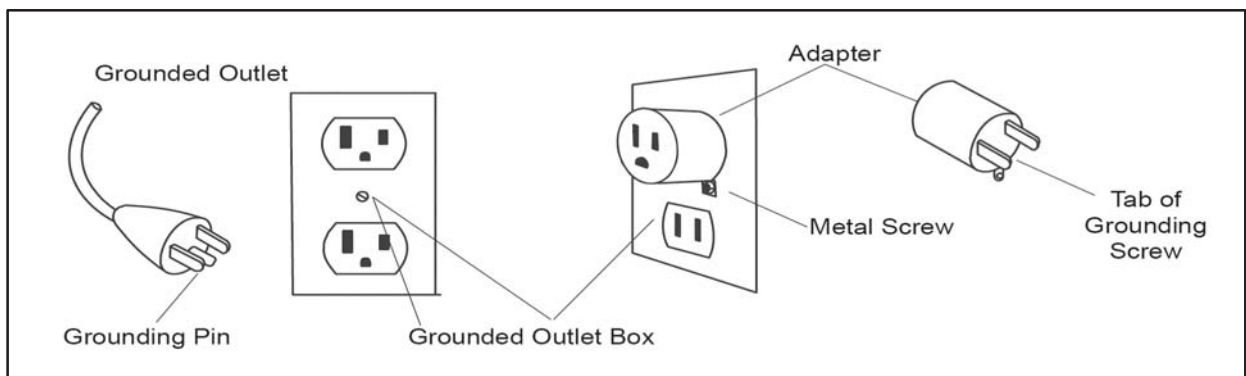

IMPORTANT OPERATION INSTRUCTIONS

- **NEVER** operate this elliptical without reading and completely understanding the results of any operational change you request from the computer.
- Understand that changes in resistance and incline do not occur immediately. Set your desired resistance level on the computer console and release the adjustment key. The computer will obey the command gradually.
- **NEVER** use your elliptical during an electrical storm. Surges may occur in your household power supply that could damage elliptical components. Unplug the elliptical during an electrical storm as a precaution.
- Use caution while participating in other activities while using your elliptical; such as watching television, reading, etc. These distractions may cause you to lose balance; which may result in serious injury.
- Always hold on to a handle bar while making control changes (incline, level, etc.).
- Do not use excessive pressure on console control keys. They are precision set to function properly with little finger pressure. If you feel the buttons are not functioning properly with normal pressure contact your **SOLE** dealer.



POWER CONNECTOR - FRONT, LEFT SIDE OF UNIT

TRANSPORT INSTRUCTIONS

The elliptical is equipped with two transport wheels which are engaged when the rear of the elliptical is lifted.

E35 ASSEMBLY PACK CHECKLIST

1

HARDWARE STEP 1

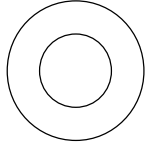

#164. 3/8" x 19 x 1.5T
Flat Washer (2 pcs)

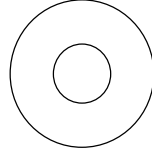

#170. 5/16" x 20 x 1.5T
Flat Washer (4 pcs)

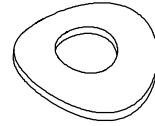

#181. 3/8" x 23 x 2T
Curved Washer (2 pcs)

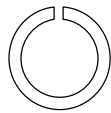

#180. 3/8" x 2T
Split Washer (1 pc)

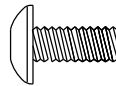

#141. M5 x 10mm
Phillips Head Screw (4 pcs)

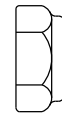

#157. 3/8" x 7T
Nylon Nut (2 pcs)



#182. 5/16" x 1.5T
Split Washer (4 pcs)

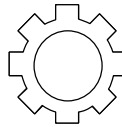

#183. 5/16"
Star Washer (4 pcs)

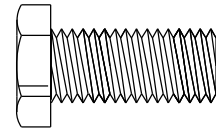

#132. 3/8" x 3/4"
Hex Head Bolt (2 pcs)

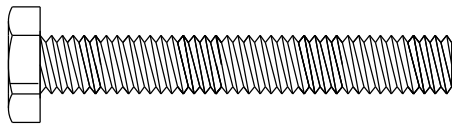

#135. 5/16" x 2-1/4"
Hex Head Bolt (4 pcs)

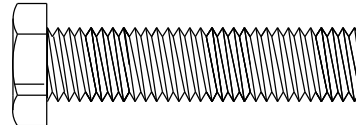

#133. 3/8" x 1-1/2"
Hex Head Bolt (2 pcs)

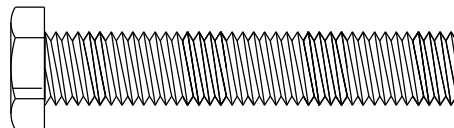

#125. 3/8" x 2-1/4"
Hex Head Bolt (1 pc)

2 HARDWARE STEP 2

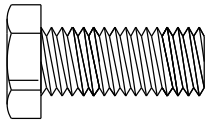

#132. 3/8" x 3/4"
Hex Head Bolt (2 pcs)

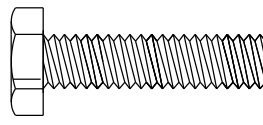

#134. 5/16" x 1-1/4"
Hex Head Bolt (2 pcs)

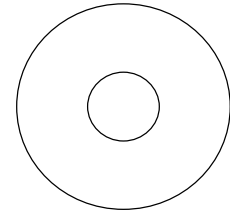

#165. 3/8" x 30 x 2T
Flat Washer (2 pcs)



#175. Ø25
Wave Washer (4 pcs)

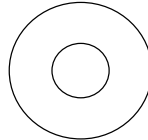

#170. 5/16" x 20 x 1.5T
Flat Washer (2 pcs)



#159. 5/16" x 7T
Nyloc Nut (2 pcs)

3 HARDWARE STEP 3

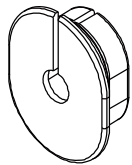

#75. Switch Wire Cap
(2 pcs)

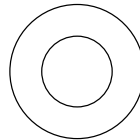

#164. 3/8" x 19 x 1.5T
Flat Washer (8 pcs)

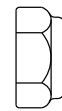

#157. 3/8" x 7T
Nyloc Nut (6 pcs)

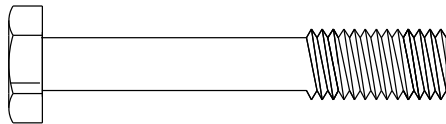

#206. 3/8" x 2-1/4"
Hex Head Bolt (6 pcs)

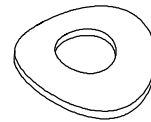

#181. 3/8" x 23 x 2T
Curved Washer (4 pcs)

4 HARDWARE STEP 4

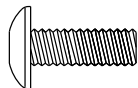

#139. M5 x 15mm
Phillips Head Screw
(29 pcs)

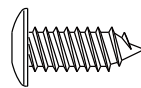

#142. 3.5 x 12mm
Sheet Metal Screw
(18 pcs)

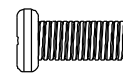

#145. M6 x 10mm
Phillips Head Screw
(4 pcs)

ASSEMBLY TOOLS

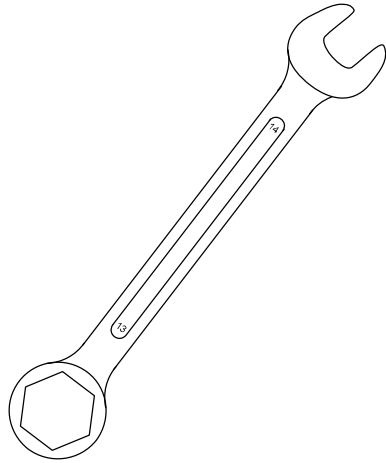

#184. 13/14mm Wrench (160mm)

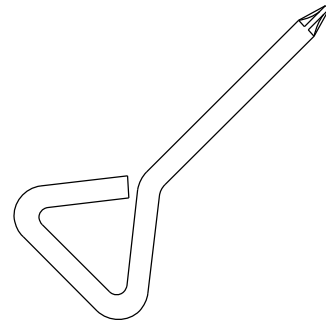

#185. Short Phillips Head Screwdriver

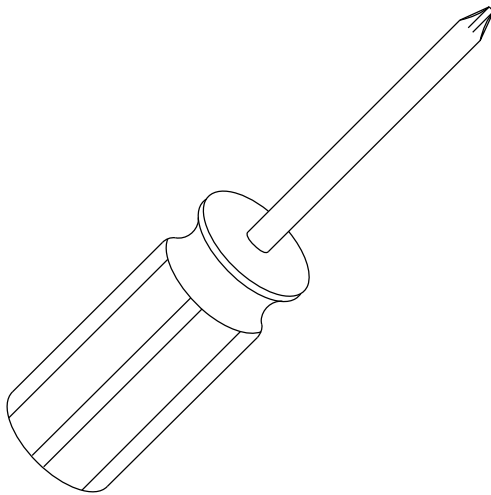

#186. Phillips Head Screwdriver

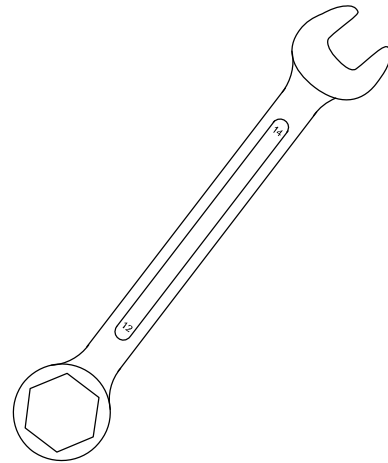

#187. 12/14mm Wrench (160mm)

E35 ASSEMBLY INSTRUCTIONS

PRE-ASSEMBLY

1. Using a razor knife (Box Cutter) cut the outside, bottom, edge of box along the dotted Line. Lift Box over the unit and unpack.
2. Carefully remove all parts from carton and inspect for any damage or missing parts. If damaged parts are found, or parts are missing, contact your dealer immediately.
3. Locate the hardware package. Remove the tools first. Remove the hardware for each step as needed to avoid confusion. The numbers in the instructions that are in parenthesis (#) are the item number from the assembly drawing for reference.

E35 ASSEMBLY INSTRUCTIONS

1 INCLINE RAIL & CONSOLE MAST

See Page 9 for Illustration

1. Install the Incline Rail Assembly (2) into the U-channel bracket of the Main Frame (1). Secure with the six bolts & associated hardware as follows: From the sides install two Hex Head Bolts (133) with two Flat Washers (164) and two Nylon Nuts (157). From the top install four Hex Head Bolts (135), four Split Washers (182), four Flat Washers (170), and four Star Washers (183), and tighten with the Wrenches provided (184 & 187).
2. Connect the three wire harness (48) to the female receiver cable coming from the Incline rail assembly (2). Connect the Three pin position Sensor connector (49) to the female receiver coming from the Incline rail assembly (2). Mate red, white, and black wires together.
3. Locate the Console Mast (12) and Console Mast Cover (96) and slide the cover onto the mast as far as it will go. Make sure the Console Mast Cover is facing the correct way. At the top opening of the Main Frame of the elliptical is a Computer Cable (50). Secure the free end of the twist tie that exits the bottom of the console mast (12) to this cable. Pull the opposite end of this twist tie up through the Console Mast (12) until the cable exits the top. Install the Console Mast (12) into the receiving bracket on the top of the Main Frame (1). Pull slightly on the Computer Cable at the top of the mast while installing. This will ensure the cable does not get pinched and shorted during Console Mast Assembly.
4. Put one Split Washer (180) onto the Long Hex Head Bolt (125) and install through the left side of the receiving bracket into the Console Mast (12). Put the two Curved Washers (181) onto the two Short Hex Head Bolts (132) and install through the front of the console mast. Using Wrench (184), tighten the (132) bolts first, then the (125) bolt, and lastly the fourth bolt, which is pre-installed, firmly. These bolts should be tightened as much as you possibly can. This is the main joint of the unit. If not tightened sufficiently, this could lead to noise and instability issues.
5. Plug all of the connectors into the back of the console; Computer Cable (50), two Hand pulse Cables (57 & 57-1), Resistance switch wire (60) and Incline switch wire (61). Secure the Console (45) on the console mounting plate with four Phillips Head Screws (141) using the screw driver (186). **Note:** there will be an empty four pin port on the back of the console. This model doesn't use this port.

HARDWARE STEP 1

#125. 3/8" x 2-1/4"
Hex Head Bolt (1 pcs)
#132. 3/8" x 3/4"
Hex Head Bolt (2 pcs)
#133. 3/8" x 1-1/2"
Hex Head Bolt (2 pcs)
#135. 5/16" x 2-1/4"
Hex Head Bolt (4 pcs)
#141. M5 x 10mm
Phillips Screw (4 pcs)
#157. 3/8" x 7T
Nylon Nut (2 pcs)
#164. 3/8" x 19 x 1.5T
Flat Washer (2 pcs)
#170. 5/16" x 20 x 1.5T
Flat Washer (4 pcs)
#180. 3/8" x 2T
Split Washer (1 pc)
#181. 3/8" x 23 x 2T
Curved Washer (2 pcs)
#182. 5/16" x 1.5T
Split Washer (4 pcs)
#183. 5/16"
Star Washer (4 pcs)

2 LOWER HANDLE BAR ARMS

See Page 9 for Illustration

1. Install two Wave Washers (175) onto the Left and Right sides of the Handle Bar axle.
2. Slide the Left (13) and Right (14) lower arms onto the appropriate side of the axle. The arms have a small sticker on them indicating L (left) and R (right).
Make sure the handlebars are facing the correct direction – see illustration.
3. Install two Flat Washers (165) onto the two Hex Head Bolts, (132) and install and tighten in the threaded holes in the ends of the axle with a wrench (187).
4. Untie the wire holding the Sleeve Spacer (24) in place on the rod-end of the Lower Handle Bar Arms (13 & 14). Align the hole in the rod ends with the hole in the brackets of the left and right Handle Bar (13 & 14). The end of connecting arms should be positioned inside the Handle Bar bracket. Secure with a Hex Head bolt (134), Flat Washer (170) and Nylon Nut (159) by using the Wrenches provided (184 & 187)

HARDWARE STEP 2

#132. 3/8" x 3/4"
Hex Head Bolt (2 pcs)
#134. 5/16" x 1-1/4"
Hex Head Bolt (2 pcs)
#159. 5/16" x 7T
Nyloc Nut (2 pcs)
#165. 3/8" x 30mm
Flat Washer (2 pcs)
#170. 5/16" x 20 x 1.5T
Flat Washer (2 pcs)
#175. Ø25
Wave Washer (4 pcs)

1 ASSEMBLY STEP 1

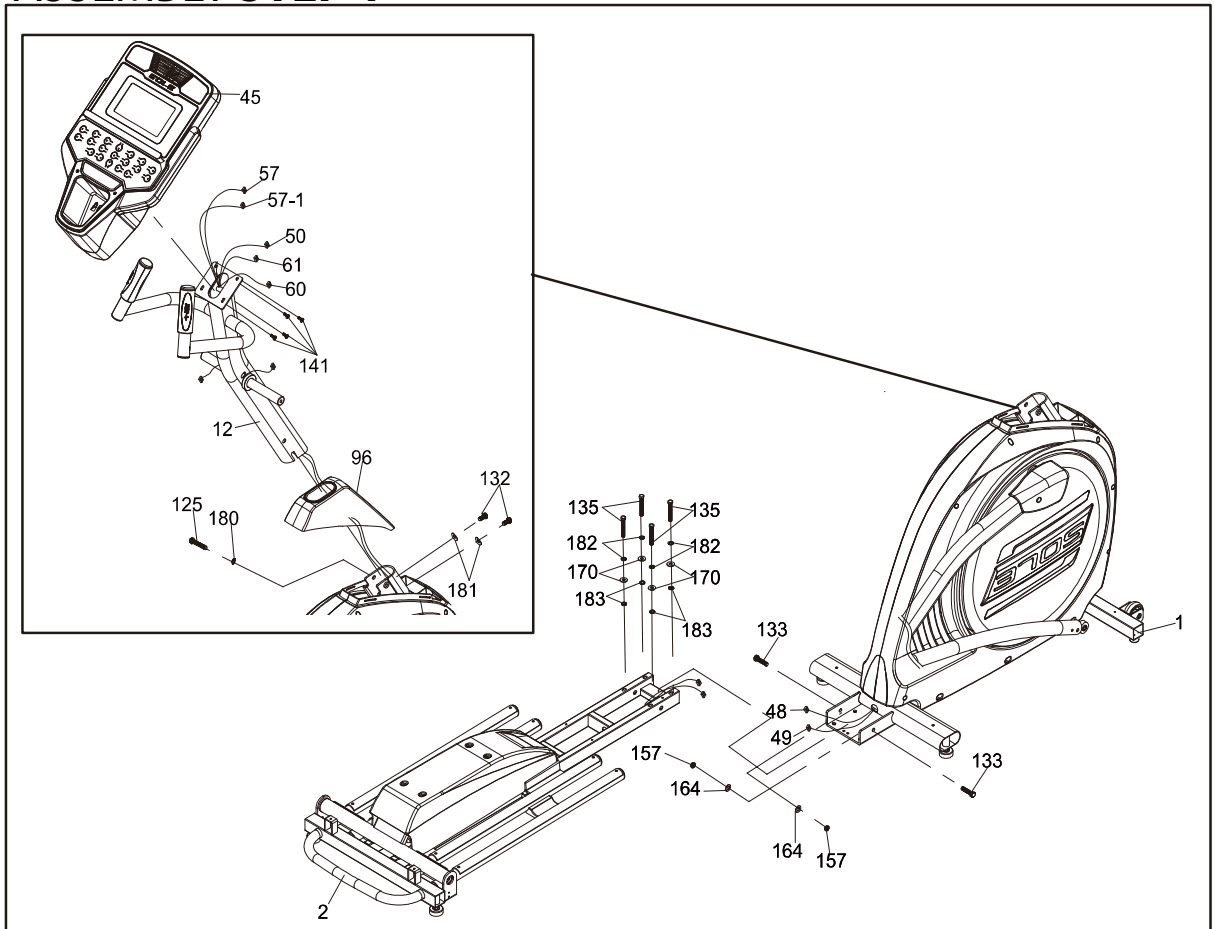

2 ASSEMBLY STEP 2

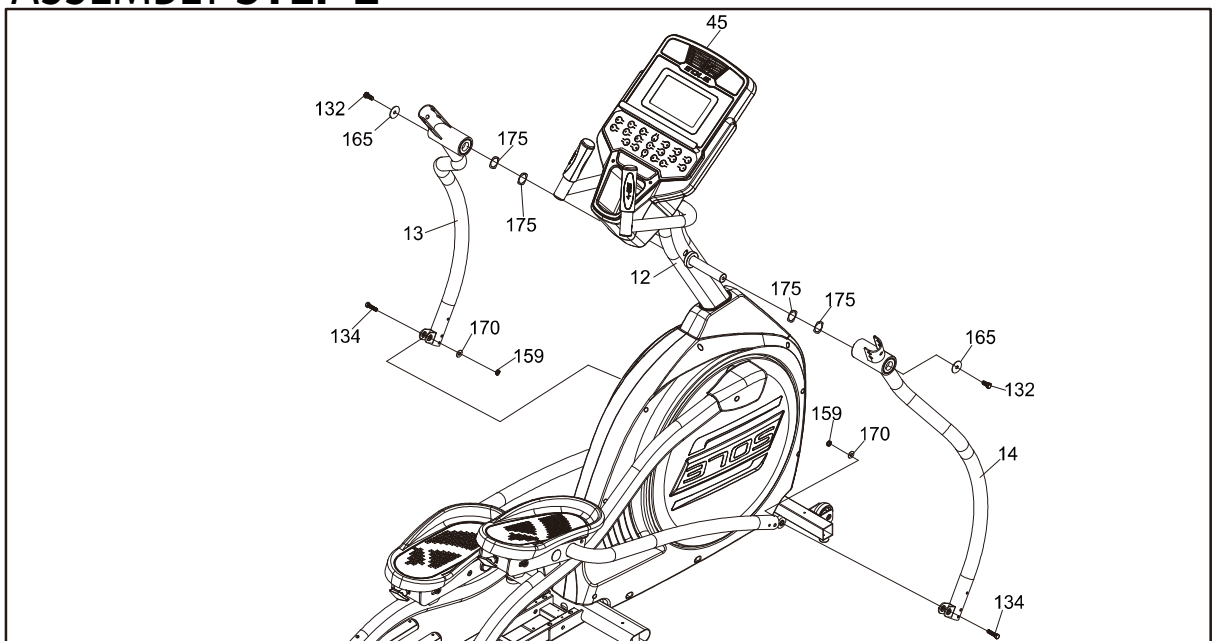

E35 ASSEMBLY INSTRUCTIONS

3 UPPER HANDLE BAR ARMS

See Page 11 for Illustration

1. Connect the Swing Arm (**L-10**) to the left Lower arm (**13**) and connect the Swing Arm (**R-11**) to the right Lower arm (**14**), and secure them with six Hex Head Bolts (**206**), eight Flat Washers (**164**), four Curved Washers (**181**) and six Nyloc Nuts (**157**) using the Wrenches (**184** & **187**).
2. Connect the two wires (**L-61** to **62** & **R-60** to **62**) on the L & R sides together and store the excess wire, including plastic connectors, back inside the console mast (**12**). Place the rubber grommets (**75**) over the wire on each side and snap them into the holes of the console mast.

HARDWARE STEP 3

#75. Switch Wire Cap (2 pcs)
#157. 3/8" x 7T Nyloc Nut (6 pcs)
#164. 3/8" x 19 x 1.5T Flat Washer (8 pcs)
#181. 3/8" x 23 x 2T Curved Washer (4 pcs)
#206. 3/8" x 2-1/4" Hex Head Bolt (6 pcs)

4 PLASTIC PARTS

See Page 11 for Illustration

Use either screw driver (185 or 186) to secure the following plastic parts.

1. Match up the console covers (**94** & **95**) and secure with three Phillips head screws (**139**) and two sheet metal screws (**142**).
2. Match up the Inner Connecting Arm Covers (**111** & **112**). Install the covers with two Sheet Metal Screws (**142**) and two Phillips Head Screws (**139**) to each joint.
3. Match up the outer Connecting Arm Covers (**109** & **110**) and install onto the Left and Right Connecting Arms (**8** & **9**). Secure each side with a Phillips Head Screw (**139**) and two Sheet Metal Screws (**142**). Make sure you position the covers with the arrows pointing up. If they are installed incorrectly, they will break.
4. Install Sliding Wheel Covers (**104**) on each side and secure with four Phillips Head Screws (**139**).
5. Install the two Stabilizer Covers (**117** & **118**) on the middle stabilizer bar with two Phillips Head Screws (**139**).
6. Install the Front Stabilizer Cover (**103**) on the front stabilizer with two Phillips Head Screws (**139**).
7. Install the two incline Cover brackets (**25**), with the hole for mounting the plastic cover on the bent tab facing rearward, and secure them on the Incline Rail Assembly (**2**) with four Phillips Head Screws (**145**). Install the Rear incline bar cover (**115**) on the rail base with two Screws (**139**).
8. Install the Rear Stabilizer Cover (**116**) on the Rear Stabilizer with four Phillips Head Screws (**139**).
9. Mate the Front Handle Bar Cover (**L-105**) and the Rear Handle Bar Cover (**L-106**) together on the Left Arm and secure with four Sheet Metal Screws (**142**) using the Phillips Head Screw Driver (**186**). Repeat the same procedure for #'s **107** & **108** on the right side.
10. This step to be performed after the elliptical power is plugged in. Elevate the incline to Level 8 and install the Incline Rail front cover (**113**) up against the middle stabilizer tube with four Phillips Head Screws (**139**).

HARDWARE STEP 4

#139. M5 x 15mm Phillips Head Screw (29 pcs)
#142. 3.5 x 12mm Sheet Metal Screw (18 pcs)
#145. M6 x 10mm Phillips Head Screw (4 pcs)

3

ASSEMBLY STEP 3

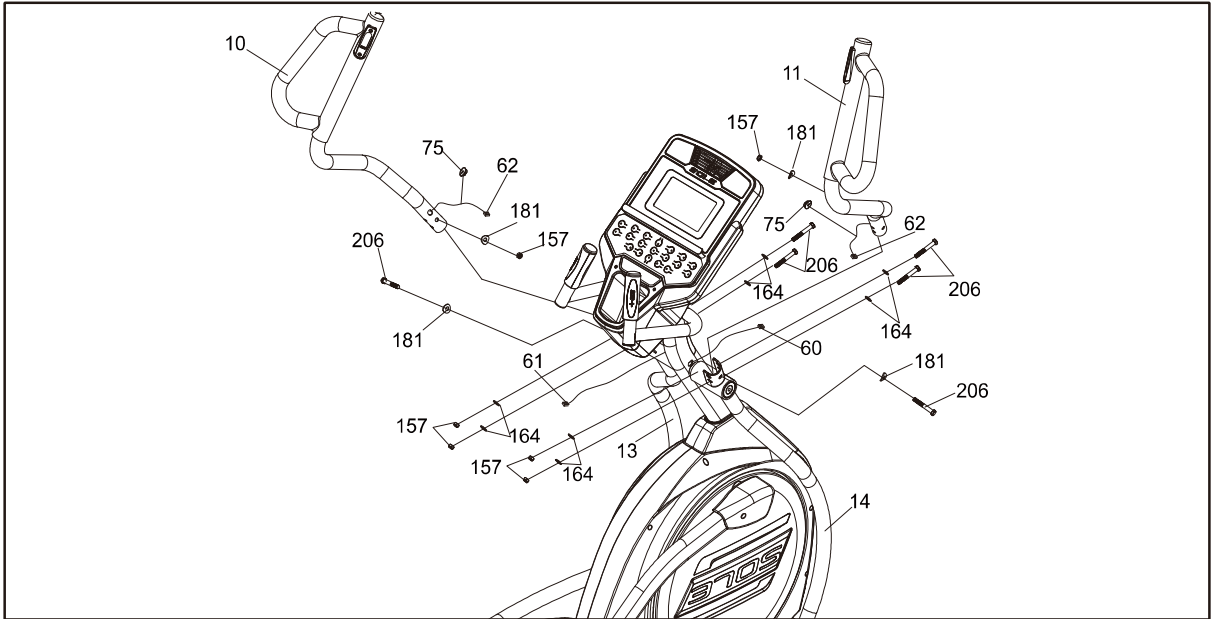

4

ASSEMBLY STEP 4

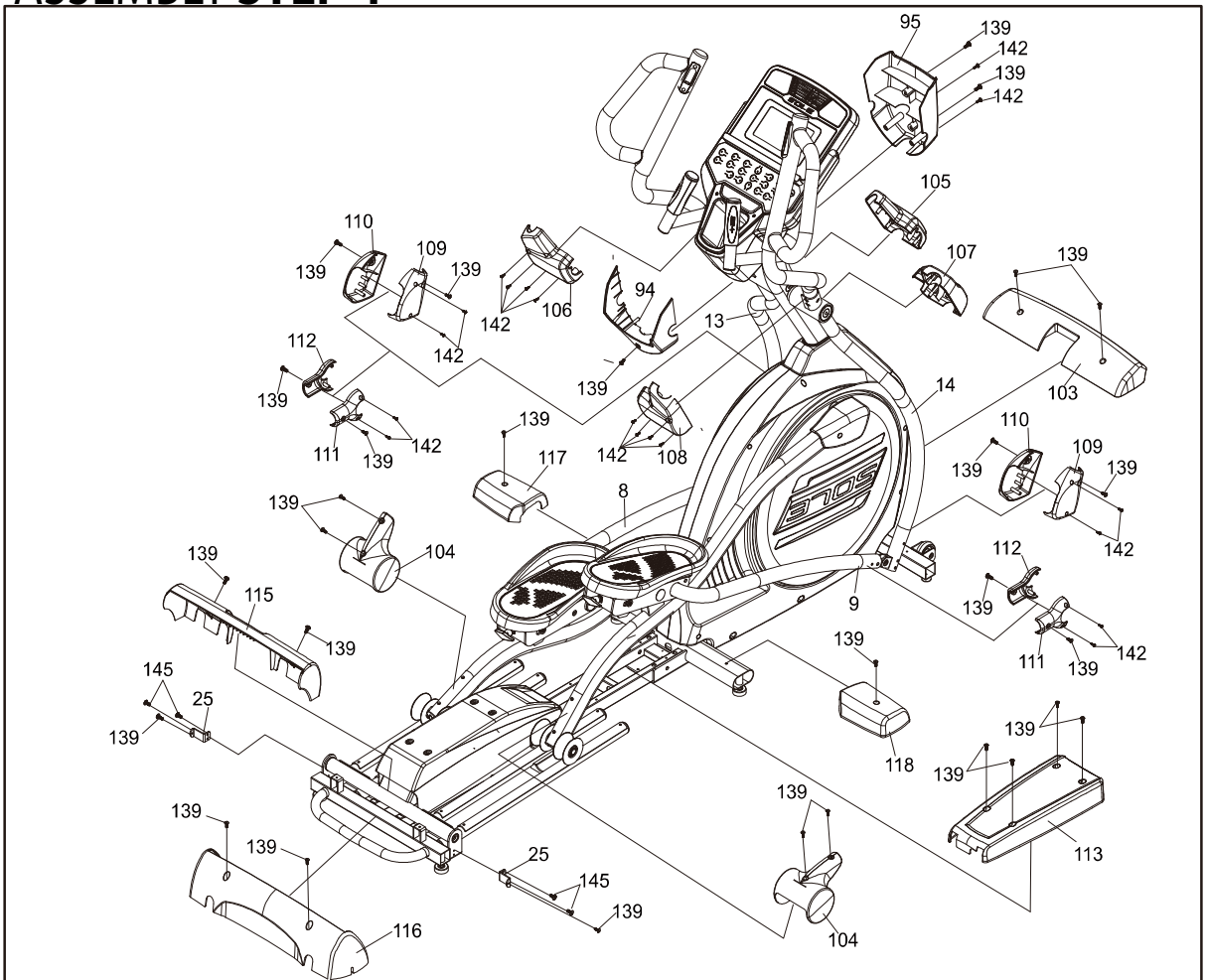

ELLIPTICAL FEATURES

ADJUSTABLE FOOT PEDAL

To adjust the three footpad angle settings, pull the red quick release handle, located under each footpad, to the rear. The lowest setting will set the footpads at zero (0) degrees, or flat, at the bottom of the elliptical stroke. The second position sets the footpad to five (5) degrees and the top position sets the footpads to ten (10) degrees.

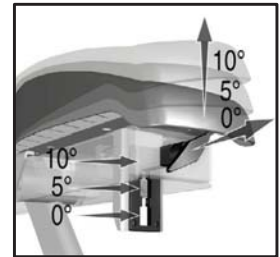

INCLINE ADJUSTMENT

Both the E35 have an incline feature that will further increase the variety of your workouts. When the incline is at its lowest position you get a normal elliptical workout. As the incline increases you will feel your knees rise higher with each step; which means you are involving more muscle fibers, due to the increased range of motion.

The E35 have a computer controlled power incline. The power incline is controlled by buttons on the console and swing arms and will automatically adjust via the incline motor during the built-in workout program.

OPERATION OF YOUR ELLIPTICAL

GETTING FAMILIAR WITH THE CONTROL PANEL

E35 CONSOLE



POWER UP

When power is connected to the elliptical the console will automatically power up. These models are connected directly to 115 VAC and there is a power switch located where the line cord plugs into the unit on the left side near the front (See page 4 for location).

When it is first powered on, the console will perform an internal self-test. During this time all the lights will turn on, the **Message Window** display will show a software version (i.e.: VER 1.0), and the **Distance Window** will display an odometer reading. The odometer shows how many virtual kilometer the elliptical has gone. The **Time Window** shows how many total hours the elliptical has been used.

The odometer and time will remain displayed for only a few seconds then the console will go to the startup display. The dot matrix display will be scrolling through the different workout profiles and the **Message Window** will be scrolling the start up message. You may now begin to use the console.

CONSOLE OPERATION

QUICK START

This is the quickest way to start a workout. After the console powers up you just press the **Start** key to begin, this will initiate the Quick Start mode. In Quick Start, the time will count up from zero. The resistance level and incline can be adjusted manually by pressing their **Level ▲/▼** buttons. The dot matrix display will be showing a track with a blinking dot indicating your progress as it travels around the track.



BASIC INFORMATION

The **Message Window** will initially display **Laps** completed. Each time the **Display** button is pressed the next set of information will appear. The order of information displayed will be: **Speed** (in MPH), **RPM** (Revolutions per minute), **Level**, **Watts**, **Segment Time** and **Data Scan** mode. In **Data Scan** mode, the displayed information will change every 4 seconds in the **Message Window**.

The Elliptical has a built in heart rate monitoring system. Simply grasping the **Contact Heart Rate Sensors** on the stationary handle bars or wearing the chest strap transmitter will start the heart (see Heart Rate Programs) Icon blinking (this may take a few seconds). The **Pulse Window** will display your heart rate in beats per minute and the HR bar graph will show your current % in relation to projected heart rate maximum. The chest strap is a more accurate and reliable method of heart rate reading. The hand pulse sensors are subject to false readings depending on user physiology and workout habits including how one grips the sensors or how sweaty their hands are.

The **Stop** button actually has several functions.

Pressing the **Stop** key once during a program will **Pause** the program for 5 minutes. If you need to get a drink, answer the phone or any of the many things that could interrupt your workout, this is a great feature. To resume your workout during **Pause** just press the **Start** key. If the **Stop** button is pressed twice during a workout the program will end and a **Workout Summary** is displayed.



If the **Stop** key is held down for 3 seconds the console will perform a complete **Reset**. During data entry for a program the **Stop** key performs a **Previous Screen** function. This allows you to go back one step in the programming each time you press the **Stop** key.

There is an **Audio In Jack** (🎵) on the front of the console and built-in speakers. You may plug any low-level audio source signal into this port. Audio sources include MP3, iPod, portable radio, CD player or even a TV or computer audio signal. There is also a **Headphone Jack** (🎧) for private listening.

PROGRAMMING THE CONSOLE

Each of the programs can be customized with your personal information and changed to suit your needs. Some of the information asked for is necessary to ensure the readouts are correct. You will be asked for your **Age** and **Weight**. Entering your **Age** is necessary during the Heart Rate control program to ensure the correct settings are entered in the program; entering your **Weight** aides in calculating a more correct **Calorie** reading. Although we cannot provide an exact calorie count we do want to be as close as possible.

A message about Calories: Calorie readings on every piece of exercise equipment, whether it is in a gym or at home, are not accurate and tend to vary widely. They are meant only as a guide to monitor your progress from workout to workout. The only way to measure your calorie burn accurately as in a clinical setting connected to a host of machines. This is because every person is different and burns calories at a different rate.

ENTERING A PROGRAM AND CHANGING SETTINGS

Press each program button to scroll through the program selections. The profile for each program will be displayed in the dot matrix window. Both models will show the incline profile also when the **Display** key is pressed. Press the **Enter** key to select a program and begin customizing the settings. If you want to workout without entering new settings, then just press the **Start** key. This will bypass the programming of data and take you directly to the start of your workout. If you want to change the personal settings, then just follow the instructions in the **Message Window**. If you start a program without changing the settings, the default settings will be used.

Note: **Age** and **Weight** default settings will change when you enter a new number. So the last **Age** and **Weight** entered will be saved as the new default settings. If you enter **Age** and **Weight** the first time you use the elliptical you will not have to enter it every time you work out unless either **Age** or **Weight** has changed or someone else enters a different **Age** and **Weight**.

New Sole App to be used in conjunction with select Apple & Android devices!

In order to help you achieve your exercise goals, Sole has added an exciting new feature to all of our products. Your new exercise machine comes equipped with a Bluetooth® transceiver that will allow it to interact with selected phones or tablet computers via the Sole Fitness App.

Just download the free Sole Fitness App from the Apple Store or Google Play, and then follow the instructions in the App to sync with your exercise machine. This allows you to view current workout data in three different Display screens on your device. Easily switch back and forth from the workout display view to internet/social media/email sites via icons on the display screen. When your workout is finished, the data is automatically saved to the built-in personal calendar for future reference.

Our new Sole Fitness App also allows you to sync your workout data with one of many fitness cloud sites we support: iHealth, MapMyFitness, Record [MyFitnessPal](#) or Fitbit.

Syncing the App with your exercise machine:

After downloading the App, make sure Bluetooth® is enabled on your device, then click the icon in the top left corner to search for Sole equipment.



After the equipment is detected, click Connect. When the App and equipment are synced, the Bluetooth® icon on the equipment's console will light up. You may now start using your new Sole product!

***Note: Your device will need to be running on a minimum operating system of iOS 7 or Android 4.4 for the Sole Fitness App to operate properly.**

PROGRAMMABLE FEATURES

MANUAL PROGRAM

The **Manual** program works as the name implies, manually. This means that you control the workload yourself and not the computer.

1. Press the **Manual** program button then press the **Enter** key.
2. The **Message Window** will ask you to enter your **Age**. You may adjust the age setting using the **Level ▲/▼** keys, then press the **Enter** key to accept the new number and proceed on to the next screen.
3. You are now asked to enter your **Weight**. You may adjust your weight setting using the **Level ▲/▼** keys, then press **Enter** to continue.
4. Next is the **Time**. You may adjust the length of **Time** by pressing the **▲/▼ Level** keys, then press **Enter** to continue.
5. Now you are finished editing the settings and can begin your workout by pressing the **Start** key. You can also go back and modify your settings by pressing the **Stop** key to go back one level of the programming screen.
6. Once the program starts the elliptical will be set to level one. This is the easiest level and it is a good idea to stay at level one for a while to warm up. If you want to increase the work load at any time press the **Level ▲** key; the **Level ▼** key will decrease the workload.
7. During the Manual program you will be able to scroll through the data in the **Message Window** by pressing the **Display** key.
8. When the program ends the **Message Window** will show a summary of your workout. The summary will be displayed for a short time then the console will return to the startup display.



PRESET PROGRAMS

The Elliptical has five different programs that have been designed for a variety of workouts. These five programs have factory preset work level profiles for achieving different goals.

Hill

The **Hill** program simulates going up and down a hill. The resistance in the pedals will steadily increase and then decrease during the program.

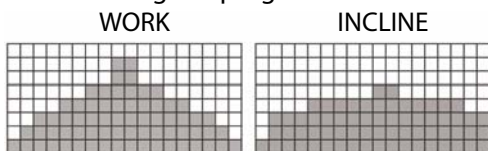

Fat Burn

The **Fat Burn** program is designed, as the name implies, to maximize the burning of fat. There are many schools of thought on the best way to burn fat but most experts agree that a lower exertion level that stays at a steady workload is the best. The absolute best way to burn fat is to keep your heart rate at around 60% to 70% of its maximum potential. This program does not use heart rate but simulates a lower, steady exertion workout.

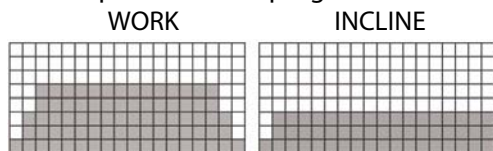

Cardio

The **Cardio** program is designed to increase your cardiovascular function and endurance. This is exercise for your heart and lungs. It will build up your heart muscle and increase blood flow and lung capacity. This is achieved by incorporating a higher level of exertion with slight fluctuations in work.

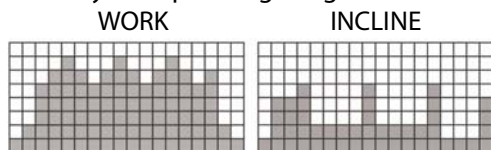

Strength

The **Strength** program is designed to increase muscular strength in your lower body. This program will steadily increase in resistance to a high level and forces you to sustain it. This is designed to strengthen and tone your legs and glutes (muscles of the butt).

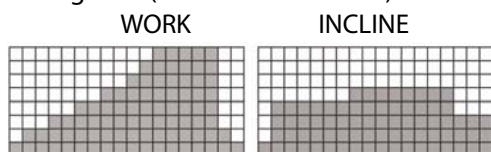

Interval

The **Interval** program takes you through high levels of intensity followed by periods of low intensity. This program increases your endurance by depleting your oxygen level followed by periods of recovery to replenish oxygen. Your cardiovascular system gets programmed to use oxygen more efficiently this way. This program also forces your body to become more efficient due to spikes in heart rate, between recovery periods. This aids in heart rate recovery from intense activities.

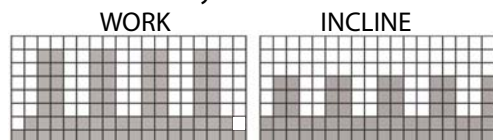

PROGRAMMING PRESET BUTTONS

1. Press the desired program button then press the **Enter** key.
2. The **Message Window** will ask you to enter your **Age**. You may adjust the age setting, using the **Level ▲/▼** keys, then press the **Enter** key to accept the new number and proceed on to the next screen.
3. You are now asked to enter your **Weight**. You may adjust the weight number using the **Level ▲/▼** keys then press **Enter** to continue.
4. Next is **Time**. You may adjust the **Time** and press **Enter** to continue.
5. Now you are asked to adjust the **Max Level**. This is the peak exertion level you will experience during the program (the highest colored segment/box of the program profile). Adjust the level and then press **Enter**.
6. You can now choose to turn on the incline profile for this program. If you choose to turn off incline, you can still control the incline manually during your workout, but the automated incline changes will be off. Press the **Enter** key when you are finished selecting.
7. Now you are finished editing the settings and can begin your workout by pressing the **Start** key. You can also go back and modify your settings by pressing the **Stop** key to go back one level, or screen.
8. If you want to increase or decrease the resistance or incline at any time during the program press the **Incline** or **Level▲/▼** keys.
9. During the program you will be able to scroll through the data in the **Message Window** by pressing the **Display** key.
10. When the program ends the **Message Window** will show a summary of your workout. The summary will be displayed for a short time then the console will return to the start-up display.



CUSTOM USER DEFINED PROGRAMS

The customizable User programs allow you to build and save your own workout. You can build your own custom program by following the instructions below.

1. Select the **User** program (**U1** or **U2**) then press **Enter**. If you have already saved a program to either **U1** or **U2**, it will be displayed and you are ready to begin. If not, you will have the option of inputting a username. In the **Message Window**, the letter "A" will be blinking. Use the **▲/▼ Level** buttons to select the appropriate first letter of your name (pressing the **Level ▲/▼** button will switch to the letter "B"; pressing the Down button will switch to letter "Z"). Press **Enter** when the desired letter is displayed. Repeat this process until all of the characters of your name have been programmed (maximum 7 characters). When finished press **Stop**.
2. If there is a program already stored in **User** when you press the key, you will have an option to run the program as it is or delete the program and build a new one. At the welcome message screen, when pressing **Start** or **Enter** you will be prompted: Run Program? Use the **Level ▲/▼** to select Yes or No. If you select No, you will then be asked if you want to delete the currently saved program. It is necessary to delete the current program if you want to build a new one.
3. The **Message Window** will ask you to enter your **Age**. You may enter your age using the **Level ▲/▼** keys, then press the **Enter** key to accept the new number and proceed on to the next screen.
4. You are now asked to enter your **Weight**. You may adjust the weight number using the **Level ▲/▼** keys, then press **Enter** to continue.
5. Next is **Time**. You may adjust the **Time** using the **Level ▲/▼** keys and press **Enter** to continue.
6. Now the first column will be blinking and you are asked to adjust the level for the first segment of the workout. When you finish adjusting the first segment, or if you don't want to change, then press **Enter** to continue to the next segment. The next segment will show the same level as the previously adjusted segment. Repeat the same process as the last segment then press **Enter**. Continue this process until all eighteen segments have been set.

7. Now the first column will be blinking again and you are asked to adjust the Incline level for the first segment of the workout. Follow the same procedure for building the Incline profile as you did for the resistance profile.
8. The **Message Window** will then tell you to start to begin (and save the program) or **Enter** to modify the program. Pressing **Stop** will exit to the start up screen.
9. If you want to increase or decrease the workload at any time during the program press the **Incline** or **Level ▲/▼** key. This will only affect the **Incline** or **Level** for the present column in the profile. When the profile changes to the next column it will return to the preset work level.
10. During the **User 1** or **User 2** program you will be able to scroll through the data in the **Message Window** by pressing the **Display** key.
11. When the program ends the Message Window will show a summary of your workout. The summary will be displayed for a short time then the console will return to the start-up display.

HEART RATE PROGRAMS

Before we get started, a word about Heart Rate:

The old motto, “no pain, no gain”, is a myth that has been overpowered by the benefits of exercising comfortably. A great deal of this success has been promoted by the use of heart rate monitors. With the proper use of a heart rate monitor, many people find that their usual choice of exercise intensity was either too high or too low and exercise is much more enjoyable by maintaining their heart rate in the desired benefit range.

To determine the benefit range in which you wish to train, you must first determine your Maximum Heart Rate. This can be accomplished by using the following formula: 220 minus your age. This will give you the Maximum Heart Rate (MHR) for someone of your age. To determine the effective heart rate range for specific goals you simply calculate a percentage your MHR. Your Heart rate training zone is 50% to 90% of your maximum heart rate. 60% of your MHR is the zone that burns fat while 80% is for strengthening the cardio vascular system. This 60% to 80% is the zone to stay in for maximum benefit.

For someone who is 40 years old their target heart rate zone is calculated:

$$\begin{aligned} 220 - 40 &= 180 \text{ (maximum heart rate)} \\ 180 \times .6 &= 108 \text{ beats per minute} \\ &\text{(60\% of maximum)} \\ 180 \times .8 &= 144 \text{ beats per minute} \\ &\text{(80\% of maximum)} \end{aligned}$$

So for a 40 year old the training zone would be 108 to 144 beats per minute.

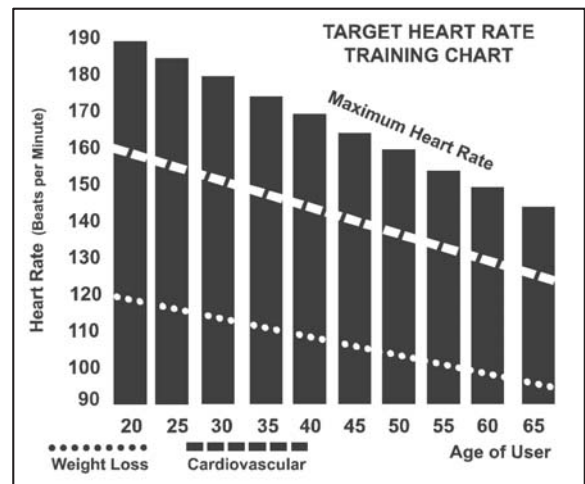

If you enter your age during programming the console will perform this calculation automatically. Entering your age is used for the Heart Rate programs. After calculating your MHR you can decide upon which goal you would like to pursue.

The two most popular reasons for, or goals, of exercise are cardiovascular fitness (training for the heart and lungs) and weight control. The black columns on the chart above represent the MHR for a person whose age is listed at the bottom of each column. The training heart rate, for either cardiovascular fitness or weight loss, is represented by two different lines that cut diagonally through the chart. A definition of the lines' goal is in the bottom left-hand corner of the chart. If your goal is cardiovascular fitness or if it is weight loss, it can be achieved by training at 80% or 60%, respectively, of your MHR on a schedule approved by your physician. Consult your physician before participating in any exercise program.

With all SOLE Heart Rate elliptical machines you may use the heart rate monitor feature without using the Heart Rate program. This function can be used during manual mode or during any of the nine different programs. The Heart Rate program automatically controls resistance at the pedals.

RATE OF PERCEIVED EXERTION

Heart rate is important but listening to your body also has a lot of advantages. There are more variables involved in how hard you should workout than just heart rate. Your stress level, physical health, emotional health, temperature, humidity, the time of day, the last time you ate and what you ate, all contribute to the intensity at which you should workout. If you listen to your body, it will tell you all of these things.

The rate of perceived exertion (RPE), also know as the Borg scale, was developed by Swedish physiologist G.A.V. Borg. This scale rates exercise intensity from 6 to 20 depending upon how you feel or the perception of your effort.

The scale is as follows:

Rating Perception of Effort

- 6 Minimal
- 7 Very,very light
- 8 Very,very light +
- 9 Very light
- 10 Very light +
- 11 Fairly light
- 12 Comfortable
- 13 Somewhat hard
- 14 Somewhat hard +
- 15 Hard
- 16 Hard +
- 17 Very hard
- 18 Very hard +
- 19 Very,very hard
- 20 Maximal

You can get an approximate heart rate level for each rating by simply adding a zero to each rating. For example a rating of 12 will result in an approximate heart rate of 120 beats per minute. Your RPE will vary depending up the factors discussed earlier. That is the major benefit of this type of training. If your body is strong and rested, you will feel strong and your pace will feel easier. When your body is in this condition, you are able to train harder and the RPE will support this. If you are feeling tired and sluggish, it is because your body needs a break. In this condition, your pace will feel harder. Again, this will show up in your RPE and you will train at the proper level for that day.

USING HEART RATE TRANSMITTER

How to wear your wireless chest strap transmitter:

1. Attach the transmitter to the elastic strap using the locking parts.
2. Adjust the strap as tightly as possible as long as the strap is not too tight to remain comfortable.
3. Position the transmitter with the SOLE logo centered in the middle of your body facing away from your chest (some people must position the transmitter slightly left of center). Attach the final end of the elastic strap by inserting the round end and, using the locking parts, secure the transmitter and strap around your chest.
4. Position the transmitter immediately below the pectoral muscles.
5. Sweat is the best conductor to measure very minute heart beat electrical signals.



5. However, plain water can also be used to pre-wet the electrodes (2 ribbed oval areas on the reverse side of the belt and both sides of the transmitter). It's also recommended that you wear the transmitter strap a few minutes before your work out. Some users, because of body chemistry, have a more difficult time in achieving a strong, steady signal at the beginning. After "warming up", this problem lessens. As noted, wearing clothing over the transmitter/strap doesn't affect performance.
6. Your workout must be within range - distance between transmitter/receiver – to achieve a strong steady signal. The length of range may vary somewhat but generally stay close enough to the console to maintain good, strong, reliable readings. Wearing the transmitter immediately against bare skin assures you of proper operation. If you wish, you may wear the transmitter over a shirt. To do so, moisten the areas of the shirt that the electrodes will rest upon.

Note: The transmitter is automatically activated when it detects activity from the user's heart. Additionally, it automatically deactivates when it does not receive any activity. Although the transmitter is water resistant, moisture can have the effect of creating false signals, so you should take precautions to completely dry the transmitter after use to prolong battery life (estimated transmitter battery life is 2500 hours). The replacement battery is Panasonic CR2032.

ERRATIC OPERATION

Caution! Do not use this elliptical for Heart Rate unless a steady, solid Actual Heart Rate value is being displayed. High, wild, random numbers being displayed indicate a problem.

Areas to look for interference which may cause erratic heart rate:

1. Microwave ovens, TV's, small appliances, etc.
2. Fluorescent lights.
3. Some household security systems.
4. Perimeter fence for a pet.
5. Some people have problems with the transmitter picking up a signal from their skin. If you have problems try wearing the transmitter upside down. Normally the transmitter will be oriented so the SOLE logo is right side up.
6. The antenna that picks up your heart rate is very sensitive. If there is an outside noise source, turning the whole machine 90 degrees may de-tune the interference.
7. Another Individual wearing a transmitter within 3' of your machine's console.

If you continue to experience problems contact your dealer.

HEART RATE PROGRAM OPERATION

Both programs operate the same, the only difference is that the default for **HR1** is set to 60% and **HR2** is set to 80% of the maximum heart rate. They both are programmed the same way.

To start an **HR** program follow the instructions below or just select the **HR1** or **HR2** program, then press the **Enter** button and follow the directions in the **Message Window**.

1. Press the **HR1** or **HR2** key, then press the **Enter** key.
2. The **Message Window** will ask you to enter your **Age**. You may enter your **Age**, using the **Level ▲/▼** keys or the numeric key pad, then press the **Enter** key to accept the new number and proceed on to the next screen.
3. You are now asked to enter your **Weight**. You may adjust the **Weight** number using the **Level ▲/▼** keys or the numeric key pad, then press **Enter** to continue.
4. Next is **Time**. You may adjust the **Time** and press **Enter** to continue.
5. Now you are asked to adjust your **Target Heart Rate**. This is the heart rate level you will strive to reach and maintain during the program. Adjust the level and then press **Enter**.
6. Now you are finished editing the settings and can begin your workout by pressing the **Start** key. You can also go back and modify your settings by pressing the **Enter** key.
*Note: At any time during the editing of Data you can press the **Stop** key to go back one level, or screen.*
7. If you want to increase or decrease the workload at any time during the program press the **Level ▲/▼** keys. This will allow you to change your **Target Heart Rate** at any time during the program.
8. During the **HR1** or **HR2** programs you will be able to scroll through the data in the **Message Window** by pressing the adjacent **Display** key.
9. When the program ends you may press **Start** to begin the same program again or **Stop** to exit the program.

GENERAL MAINTENANCE

1. Wipe down all areas in the sweat path with a damp cloth after each workout.
2. If a squeak, thump, clicking or rough feeling develops the main cause is most likely one of two reasons:
 - I. The hardware was not sufficiently tightened during assembly. All bolts that were installed during assembly need to be tightened as much as possible. It may be necessary to use a larger wrench than the one provided if you cannot tighten the bolts sufficiently. I cannot stress this point enough; 90% of calls to the service department for noise issues can be traced to loose hardware or the rear rails being dirty.
 - II. Dirt build-up on the rear rails and polyurethane wheels are also a source of noise. Noise from build-up on the rails can cause a thumping sound that you would swear is coming from inside the main body of the machine because noise travels, and is amplified in the tubing of the frame. Clean the rails and wheels with a lint free cloth and rubbing alcohol. Stubborn build-up can be removed with your thumbnail or a non-metallic scraper, like the back edge of a plastic knife. After cleaning, apply a small amount of lubricant on the rails with your fingers or a lint free cloth. You only need a thin coat of lubrication, wipe off any excess.
3. If squeaks or other noises persist, check that the unit is properly leveled before calling the service department.

MAINTENANCE MENU IN CONSOLE SOFTWARE

The console has built in maintenance/diagnostic software. The software will allow you to change the console settings from English to Metric and turn off the beeping of the speaker when a key is pressed for example. To enter the Maintenance Menu (may be called Engineering Mode, depending on version) press and hold down the **Start**, **Stop** and **Enter** keys keep holding the keys down for about 5 seconds and the **Message Window** will display "Engineering Mode". Press the **Enter** button to access the menu below. Press the **Level** ▲ / ▼ keys to navigate the menu.

- A. **Key Test** - Will allow you to test all the keys to make sure they are functioning
- B. **Display Test** - Automatically tests all LCD's
- C. **Functions** - Press **Enter** to access settings, use **Level** ▲ / ▼ keys to scroll
 - I. **ODO Reset** - Resets the odometer
 - II. **Units** - Choose from English(Imperial) or Metric display readings
 - III. **Display Mode** - Turn off to have the console power down automatically after 30 minutes of inactivity
 - IV. **Motor Test** - Continually runs the tensioning gear motor
 - V. **Manual** - Allows stepping of the gear motor
 - VI. **Pause Mode**-Turn on to allow 5 minutes of pause, turn off to have console pause indefinitely
 - VII. **Key Tone** - Turn on or off the beep sound when a key is pressed
- D. **Security** - Allows you to lock the keypad so no unauthorized use of the machine is allowed. When the child lock is enabled, the console will not allow the keypad to operate unless you press and hold the **Start** and **Enter** buttons for 3 seconds to unlock the console.
- E. **Factory Set**
- F. **Exit** - Select to exit Maintenance Menu

Incline Calibration: If there is a problem with the incline, try running the calibration. Press the **Incline** ▲ key and the **Start** key at the same time. Hold them down for 5 seconds and the Incline calibration will start and run automatically. If the problem persists contact Sole service department.

MANUFACTURER'S LIMITED WARRANTY

ELLIPTICAL WARRANTY

**Effective February 1,
2016**

SOLE warrants all its elliptical parts for a period of time listed below from the date of retail sale, as determined by sale receipt, or in the absence of a sales receipt eighteen (18) months from the original factory shipping date. SOLE's responsibilities include providing new or remanufactured parts, at SOLE's option, and technical support to our independent dealers and servicing organizations. In the absence of a dealer or service organization, these warranties will be administered by SOLE directly to a consumer. The warranty period applies to the following components:

E35

Labor	2 Years
Frame Weldments	Lifetime
Brake	Lifetime
Cosmetic Items*	90 Days
All Other Components	5 Years

* Cosmetic items including, but not limited to the following: grips, console overlays, and labels/decals.

NORMAL RESPONSIBILITIES OF THE CONSUMER

This warranty applies only to products in ordinary household use, and the consumer is responsible for the items listed below:

1. The warranty registration card must be completed and returned to the address listed on the card within 10 days of the original purchase to validate the manufacturer's limited warranty.
2. Proper use of the elliptical in accordance with the instructions provided in this manual
3. Proper installation in accordance with instructions provided with the elliptical and with all local electric codes.
4. Proper connection to a grounded power supply of sufficient voltage, replacement of blown fuses, repair of loose connections or defects in house wiring.
5. Expenses for making the elliptical accessible for servicing, including any item that was not part of the elliptical at the time it was shipped from the factory.
6. Damages to the elliptical finish during shipping, installation or following installation.
7. Routine maintenance of this unit as specified in this manual.

EXCLUSIONS

This warranty does not cover the following:

1. CONSEQUENTIAL, COLLATERAL, OR INCIDENTAL DAMAGES SUCH AS PROPERTY DAMAGE AND INCIDENTAL EXPENSES RESULTING FROM ANY BREACH OF THIS WRITTEN OR ANY IMPLIED WARRANTY.
Note: Some states do not allow the exclusion or limitation of incidental or consequential damages, so this limitation or exclusion may not apply to you.
2. Service call reimbursement to the consumer. Service call reimbursement to the dealer that does not involve malfunction or defects in workmanship or material, for units that are beyond the warranty period, for units that are beyond the service call reimbursement period, for elliptical not requiring component replacement, or elliptical not in ordinary household use.
3. Damages caused by services performed by persons other than authorized SOLE service companies; use of parts other than original SOLE parts; or external causes such as corrosion, discoloration of paint or plastic, alterations, modifications, abuse, misuse, accident, improper maintenance, inadequate power supply, or acts of God.
4. Products with original serial numbers that have been removed or altered.
5. Products that have been: sold, transferred, bartered, or given to a third party.
6. Products that do not have a warranty registration card on file at SOLE. SOLE reserves the right to request proof of purchase if no warranty record exists for the product.
7. THIS WARRANTY IS EXPRESSLY IN LIEU OF ALL OTHER WARRANTIES EXPRESSED OR IMPLIED, INCLUDING THE WARRANTIES OF MERCHANTABILITY AND/OR FITNESS FOR A PARTICULAR PURPOSE.
8. Product use in any environment other than a residential setting.
9. Warranties outside of North America may vary. Please contact your local dealer for details.

SERVICE

Keep your bill of sale. Twelve (12) months from the date on the bill of sale or eighteen (18) months from the date of factory shipping as determined by the serial number establishes the labor warranty period should service be required. If service is performed, it is in your best interest to obtain and keep all receipts. This written warranty gives you specific legal rights. You may also have other rights that vary from state to state. Service under this warranty must be obtained by following these steps, in order:

1. Contact your selling authorized SOLE dealer. OR
2. Submit all service requests including serial number, contact information and a brief description of the problem online at <http://www.soletreadmills.com/serviceparts.html>.
3. If you have any questions about your new product or questions about the warranty contact SOLE Fitness at 1-866-780-SOLE (7653). If you have a technical problem with your new elliptical contact SOLE technical service at 866-MYSOLE1 (697-6531).
4. If no local service is available, SOLE will repair or replace the parts, at SOLE's option, within the warranty period at no charge for parts. All transportation costs, both to our factory and upon return to the owner, are the responsibility of the owner. The owner is responsible for adequate packaging upon return to SOLE. SOLE is not responsible for damages that occur during shipping. Make all freight damage claims with the appropriate freight carrier. DO NOT SHIP ANY UNIT TO OUR FACTORY WITHOUT A RETURN AUTHORIZATION NUMBER. All units arriving without a return authorization number will be refused.
5. For any further information, or to contact our service department by mail, send your correspondence to:

**SOLE Fitness
P.O. Box 2037
Jonesboro, AR 72402-2037**

Product features or specifications as described or illustrated are subject to change without notice. All warranties are made by SOLE.

Before returning your Sole product to any retailer, or if you require any assistance with assembly or technical support please call us first for assistance at 866-697-6531. Thank you for your Sole purchase.

SOLE[™]
FITNESS